

2022



ACCESSORI NAUTICI / NAUTICAL ACCESSORIES





Gli articoli presenti in questo catalogo sono interamente prodotti nei
7000 metri quadrati degli stabilimenti di Genova Italia
(foto pagine 10 e 11).

Una realtà tutta italiana da quarant'anni nel mondo della nautica.

*The articles in this catalogue are entirely manufactured in the 7000
square meters of establishments in Genoa Italy
(photos pages 10 and 11).*

One all-Italian company for forty years in the nautical world.



**SISTEMI AUDIO
AUDIO SYSTEM**

- 14. RIVIERA BLUETOOTH SOUND SYSTEMS
- 15. RIVIERA BLUETOOTH AMPLIFIER
- 16. 200W LOUDSPEAKERS
- 17. SUBWOOFER - COVER
- 18. 120W LOUDSPEAKERS
- 20. 80W LOUDSPEAKERS
- 22. 60W & 10W LOUDSPEAKERS

**SISTEMI DI GUIDA MECCANICI
MECHANICAL STEERING SYSTEMS**

- 24. STEERING SYSTEMS- MECHANICAL STEERING SYSTEMS
- 31. STEERING SYSTEMS- MECHANICAL STEERING SYSTEMS -KIT
- 33. STEERING SYSTEMS- MECHANICAL STEERING SYSTEMS ACCESSORIES

**SISTEMI DI GUIDA IDRAULICI
HYDRAULIC STEERING SYSTEMS**

- 35. STEERING SYSTEMS - HYDRAULIC STEERING SYSTEMS
- 37. STANDARD FEATURES/HOW THE SYSTEM WORKS
- 40. STEERING SYSTEMS- HYDRAULIC STEERING SYSTEMS IN KIT OUTBOARD
- 45. HYDRAULIC STEERING SYSTEM
- 47. STEERING SYSTEMS- HYDRAULIC STEERING SYSTEMS IN KIT INBOARD
- 52. STEERING SYSTEMS- HYDRAULIC STEERING SYSTEMS CONNECTION
- 59. STEERING SYSTEMS- HYDRAULIC STEERING SYSTEMS ACCESSORIES

**VOLANTI
STEERING WHEELS**

- 63. VR SERIES
- 65. VS SERIES

**COMANDI
LEVER CONTROLS**

- 69. ONE LEVER CONTROLS
- 71. TWO LEVER CONTROLS

**CAVI CONTROLLO MOTORE
ENGINE CONTROL CABLES**

- 75. ENGINE CONTROL CABLES
- 79. ENGINE CONTROL CABLES - LOW FRICTION
- 81. ENGINE CONTROL CABLES - UNIVERSAL CABLES
- 82. ENGINE CONTROL CABLES - OMC - JOHNSON - EVINRUDE
- 84. ENGINE CONTROL CABLES - MERCURY - MERCUISER - MARINER
- 86. ENGINE CONTROL CABLES - ACCESSORIES

**ACCESSORI
ACCESSORIES**

- 88. ACCESSORIES/SECURITY STOP KEYS FOR OUTBOARD ENGINES
- 89. ACCESSORIES/HAND PRIMER/FUEL HOSE
- 90. ACCESSORIES / FUEL LINE CONNECTORS
- 92. ACCESSORIES / DRAIN PLUGS
- 95. TANK

**BUSSOLE MAGNETICHE
MAGNETIC COMPASSES**

- 105. WHITE STAR SERIES 6"
- 111. WHITE STAR SERIES 5"
- 119. URANIA SERIES 4"
- 130. ASTRA SERIES 4"
- 133. POLARE SERIES 4" & 3"
- 138. ZENITH SERIES 3"
- 150. ARTICA SERIES 2"3/4
- 161. STELLA SERIES 2"1/2
- 165. ARIES SERIES 2"1/2
- 168. COMET SERIES 2"1/2
- 170. PRISMA SERIES 2"1/4
- 172. ORION/MIZAR SERIES 1"7/8
- 174. DIVING COMPASSES



IONet, the association of the world's first class certification bodies, is the largest provider of management System Certification in the world. IONet is composed of more than 30 bodies and counts over 150 subsidiaries all over the globe.

CERTIFICATO N. 3828/00/S
CERTIFICATE No.

SI CERTIFICA CHE IL SISTEMA DI GESTIONE PER LA QUALITÀ DI
IT IS HEREBY CERTIFIED THAT THE QUALITY MANAGEMENT SYSTEM OF

RIVIERA SOCIETA' A RESPONSABILITA' LIMITATA GENOVA

VIA INFERIORE RIO MAGGIORE 4 A 16123 Genova (GE) ITALIA

NELLE SEGUENTI UNITÀ OPERATIVE / *IN THE FOLLOWING OPERATIONAL UNITS*

VIA INFERIORE RIO MAGGIORE 4 A 16123 Genova (GE) ITALIA

È CONFORME ALLA NORMA / *IS IN COMPLIANCE WITH THE STANDARD*

ISO 9001:2015

PER I SEGUENTI CAMPI DI ATTIVITÀ / *FOR THE FOLLOWING FIELD(S) OF ACTIVITIES*

PROGETTAZIONE E PRODUZIONE DI BUSSOLE, ALTOPARLANTI AMAGNETICI E SISTEMI DI GOVERNO ELETTRICI, ELETTRONICI, IDRAULICI.

DESIGN AND PRODUCTION OF COMPASSES, ANTIMAGNETIC SPEAKERS AND ELECTRIC, ELECTRONIC AND HYDRAULIC STEERING SYSTEMS.

La validità del presente certificato è subordinata a sorveglianza periodica annuale / semestrale ed al riesame completo del sistema di gestione con periodicità triennale
The validity of this certificate is dependent on an annual / six monthly audit and on a complete review, every three years, of the management system
L'uso e la validità del presente certificato sono soggetti al rispetto del documento RINA: Regolamento per la Certificazione di Sistemi di Gestione per la Qualità
The use and validity of this certificate are subject to compliance with the RINA document : Rules for the certification of Quality Management Systems

Prima emissione <i>First Issue</i>	27.09.2000	Data decisione di rinnovo <i>Renewal decision date</i>	25.12.2018
Data scadenza <i>Expiry Date</i>	25.12.2021	Data revisione <i>Revision date</i>	25.12.2018

Daniela Asaro
Genoa Management System
Certification, Head

RINA Services S.p.A.
Via Corsica 12 - 16128 Genova Italy



www.cisq.com



SGQ N° 002 A

Membro degli Accordi di Mutuo Riconoscimento EA, IAF e ILAC
Signatory of EA, IAF and ILAC Mutual Recognition Agreements



CISQ è la Federazione Italiana di Organismi di Certificazione dei sistemi di gestione aziendale
CISQ is the Italian Federation of management system Certification Bodies

Foto: CERTIFICAZIONE 02/09/08



THE INTERNATIONAL CERTIFICATION NETWORK

CERTIFICATE

CISQ /RINA has issued an IQNet recognized certificate that the organization:

RIVIERA SOCIETA' A RESPONSABILITA' LIMITATA GENOVA

VIA INFERIORE RIO MAGGIORE 4 A 16123 Genova (GE) ITALIA

in the following operative units:

VIA INFERIORE RIO MAGGIORE 4 A 16123 Genova (GE) ITALIA

has implemented and maintains a
Quality Management System

for the following scope:

DESIGN AND PRODUCTION OF COMPASSES, ANTIMAGNETIC SPEAKERS AND ELECTRIC, ELECTRONIC AND HYDRAULIC STEERING SYSTEMS.

which fulfills the requirements of the following standard:

ISO 9001:2015

Issued on: 2018-12-25

First Issued on: 2000-09-27

Expires on: 2021-12-25

This attestation is directly linked to the IQNet Partner's original certificate and shall not be used as a stand-alone document

CISQ/RINA original certificate no.: 3828/00/S

Registration Number: IT-14616



Alex Stoichitoiu
President of IQNET



Ing. Claudio Provetti
President of CISQ

IQNet Partners*:

AENOR Spain AFNOR Certification France APCER Portugal CCC Cyprus CISQ Italy
CQC China CQM China CQS Czech Republic Cro Cert Croatia DQS Holding GmbH Germany FCAV Brazil
FONDONORMA Venezuela ICONTEC Colombia Inspecta Sertifointi Oy Finland INTECO Costa Rica
IRAM Argentina JQA Japan KFQ Korea MIRTEC Greece MSZT Hungary Nemko AS Norway NSAI Ireland
NYCE-SIGE México PCBC Poland Quality Austria Austria RR Russia SII Israel SIQ Slovenia
SIRIM QAS International Malaysia SQS Switzerland SRAC Romania TEST St Petersburg Russia TSE Turkey YUQS Serbia
IQNet is represented in the USA by: AFNOR Certification, CISQ, DQS Holding GmbH and NSAI Inc.

* The list of IQNet partners is valid at the time of issue of this certificate. Updated information is available under www.iqnet-certification.com

POLITICA A FAVORE DELLA QUALITÀ, DELL'AMBIENTE E DELLA SICUREZZA
POLICY IN FAVOR OF QUALITY, ENVIRONMENT AND SAFETY

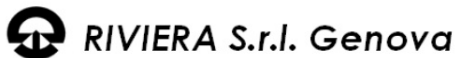

Politica per la Qualità

La MISSIONE che RIVIERA S.r.l. Genova si prefigge è:

- o progettare e produrre bussole, altoparlanti e sistemi di governo per la nautica al più alto livello qualitativo, rispondenti alle aspettative dei Clienti
- o garantire le necessarie condizioni di sicurezza e salute sul lavoro del proprio personale e di quello delle imprese appaltatrici o compresenti
- o operare salvaguardando l'ambiente interno ed esterno al proprio stabilimento.

La POLITICA PER LA QUALITÀ di RIVIERA S.r.l. Genova è pertanto:

- ✓ soddisfare le esigenze e le aspettative del Cliente mediante la loro esatta definizione, il rispetto dei termini contrattuali, la prevenzione e la gestione delle non conformità, dei resi e dei reclami; impegnarsi a fornire al Cliente assistenza post-vendita, anche in casi di fuori garanzia se giudicato strategico;
- ✓ soddisfare le esigenze e le aspettative delle altre parti interessate, significative per il buon andamento delle attività;
- ✓ gestire correttamente le attività, mediante la pianificazione ed il controllo dei processi;
- ✓ contribuire alla crescita della competenza e della professionalità del proprio personale, del suo spirito di appartenenza, dell'efficienza ed efficacia del suo operato, mediante
 - la condivisione della Politica e degli Obiettivi per la Qualità
 - la condivisione delle conoscenze organizzative
 - attività idonee di formazione ed aggiornamento;
- ✓ garantire il pieno rispetto delle prescrizioni di legge e volontarie applicabili al fine di realizzare prodotti a norma per differenziarsi dalla concorrenza e consolidare la nicchia di mercato
- ✓ adottare i processi tecnologici, economicamente sostenibili, che offrono i migliori rendimenti qualitativi nel rispetto pieno dell'ambiente, della salute e della sicurezza dei lavoratori
- ✓ perseguire il miglioramento continuo dei processi e dell'efficacia complessiva del proprio Sistema di Gestione per la Qualità secondo la norma UNI EN ISO 9001:2015.

Per dare attuazione alla Politica per la Qualità, la Direzione:

- determina i rischi e le opportunità per la gestione, l'efficacia ed il miglioramento del Sistema di Gestione per la Qualità
- definisce gli obiettivi per la qualità precisando i relativi indicatori, le modalità di misurazione e controllo, gli indici di miglioramento perseguibili;
- valuta la congruità delle risorse disponibili, provvedendo alle necessarie integrazioni;
- assicura la necessaria informazione e formazione del personale;
- analizza le performance dei processi, individuando le eventuali cause del mancato conseguimento degli obiettivi di miglioramento precedentemente fissati ed adottando i provvedimenti correttivi necessari.

Tutti i collaboratori della RIVIERA S.R.L. GENOVA sono tenuti a dare il proprio contributo per la completa soddisfazione delle esigenze della Clientela e per la migliore attuazione del Sistema di Gestione per la Qualità.

MEANS OF RESCUE AND MINIMUM SAFETY EQUIPMENT TO KEEP ON BOARD OF BOATS AND VESSELS OF PLEASURE CONSIDERING THE DISTANCE FROM THE COST OR FROM THE SHORE.

SPECIES OF NAVIGATION
(the "X" means obligation, the number in parenthesis indicates the quantity)

A) Safety equipment for the units' pleasure (with or without the marking CE)

	Without any limit	Without 50 miles	Without 12 miles	Without 6 miles	Without 3 miles	Without 1 miles	Without 300 meters	In rivers, torrents and in streams
<i>liferaft for all people on board</i>	X	X						
<i>buoyant apparatus for all people on board</i>			X					
<i>rescue belts (one belt for any person on board)</i>	X	X	X	X	X	X		X
<i>lifebuoy with line</i>	X (1)	X (1)	X (1)	X (1)	X (1)	X (1)		X (1)
<i>light buoy</i>	X (1)	X (1)	X (1)	X (1)				
<i>smoke buoy</i>	X (3)	X (2)	X (2)	X (2)	X (1)			
<i>compass and deviation table (a)</i>	X	X	X					
<i>clock</i>	X	X						
<i>barometer</i>	X	X						
<i>binoculars</i>	X	X						
<i>nautical charts of the area in which there is the navigation</i>	X	X						
<i>instruments Charts</i>	X	X						
<i>hand flares red light</i>	X (4)	X (3)	X (2)	X (2)	X (2)			
<i>parachute flares red light</i>	X (4)	X (3)	X (2)	X (2)				
<i>first aid kit (b)</i>	X	X						
<i>navigation lights (c)</i>	X	X	X	X	X			
<i>sound signaling devices</i>	X	X	X	X	X			
<i>tool radiopositioning</i>	X	X						
<i>apparatus WHF</i>	X	X	X					
<i>a radio spot</i>	X	X						
<i>E.P.I.R.B. (Emergency Position Indicating Radio Beacon)</i>	X							

B) additional safety equipment for the units without marking CE

<i>pump or other tool of exhaustion</i>	X	X	X	X	X	X		
<i>Fire – fighting equipment / fire extinguishers, as showed at the table all.</i>	X	X	X	X	X	X		
<i>A) attached to the Decree of the Ministry 21 January 1994 n. 232 (e)</i>								

Notes:

- a) the deviation tables are mandatory for the pleasure boats.
- b) according with the attached D table to the Decree of the Ministry of Health n. 279 of the 28 May 1988.
- c) in case of day time navigation up to 12 miles from the cost, the navigation lights can be replaced with a safety torch with a white light.
- d) for the units with a length exceeding 12 meters is mandatory also the whistle and the bell. (The bell can be replaces with a portable sound device).
- e) the boats, regardless of the power of the engine, must have on board just 1 fire extinguisher. For the boats, the number of the 1 fire extinguishers and the extinguishing capacity are fixed at the LETTER "A" of the table attached to the cited D.M. 232/1994 (ORDER of MINISTER 232/1994)

**MEZZI DI SALVATAGGIO E DOTAZIONI DI SICUREZZA MINIME DA TENERE
A BORDO DELLE IMBARCAZIONI E NATANTI DI PORTO IN RELAZIONE ALLA
DISTANZA DALLA COSTA O DALLA RIVA**

SPECIE DI NAVIGAZIONE
(la "X" indica l'obbligatorietà - il numero tra parentesi indica le quantità)

A) Dotazioni di sicurezza per le unità da diporto (con o senza marcatura CE)

	Senza alcun limite	Entro 50 miglia	Entro 12 miglia	Entro 6 miglia	Entro 3 miglia	Entro 1 miglia	Entro 300 metri	Nei fiumi torrenti e corsi d'acqua
zattera di salvataggio (per tutte le persone a bordo)	X	X						
apparecchi galleggianti (per tutte le persone a bordo)			X					
cinture di salvataggio (una per ogni persona a bordo)	X	X	X	X	X	X		X
salvagente anulare con cima	X (1)	X (1)	X (1)	X (1)	X (1)	X (1)		X (1)
boetta luminosa	X (1)	X (1)	X (1)	X (1)				
boetta fumogena	X (3)	X (2)	X (2)	X (2)	X (1)			
bussola e tabelle di deviazione (a)	X	X	X					
orologio	X	X						
barometro	X	X						
binocolo	X	X						
carte nautiche della zona in cui si effettua la navigazione	X	X						
strumenti da carteggio	X	X						
fuochi a mano a luce rossa	X (4)	X (3)	X (2)	X (2)	X (2)			
razzi a paracadute a luce rossa	X (4)	X (3)	X (2)	X (2)				
cassetta di pronto soccorso (b)	X	X						
fanali regolamentari (c)	X	X	X	X	X			
apparecchi di segnalazione sonora	X	X	X	X	X			
strumento di radioposizionamento	X	X						
appartato VHF	X	X	X					
riflettore radar	X	X						
E.P.I.R.B. (Emergency Position Indicating Radio Beacon)	X							

B) Ulteriori dotazioni di sicurezza per le unità senza marcatura CE

Pompa o altro attrezzo di esaurimento	X	X	X	X	X	X		
Mezzi antincendio - estintori: come indicato nella Tabella Ali. A) annessa al D.M. 21 gennaio 1994 n. 232 (e)	X	X	X	X	X	X		

Note:

- le tabelle di deviazioni sono obbligatorie solo per le imbarcazioni da diporto.
- secondo la tabella D allegata al Decreto del Ministero della Sanità n. 279 del 28 maggio 1988.
- nel caso di navigazione diurna fino a dodici miglia dalla costa i fanali regolamentari possono essere sostituiti con una torcia di sicurezza a luce bianca.
- per le unità aventi una lunghezza superiore a metri 12 è obbligatorio anche il fischio e la campana. (la campana può essere sostituita da un dispositivo sonoro portatile).
- i natanti, indipendentemente dalla potenza del motore, devono avere a bordo solo un estintore. Per le imbarcazioni, il numero degli estintori e la capacità estinguente sono stabiliti alla lettera "A" della tabella annessa al citato D.M. 232/1994.



L'AZIENDA THE COMPANY



∞ PRESENCE AREA/HOW TO REACH US

Riviera srl Genova dal 1976, anno della sua nascita, si dedica alla progettazione, alla costruzione e allo sviluppo delle bussole magnetiche e degli accessori nautici.

Il passare del tempo e il costante sviluppo hanno portato **Riviera srl Genova** ad avere prodotti molto affidabili e aggiornati tecnicamente, sempre mantenendo la tradizione marinara della semplicità e praticità del suo utilizzo.

Tutto ciò ha fatto sì che i suoi prodotti sono presenti in tutta la cantieristica navale sia da diporto che da lavoro.

Le Certificazioni e le Approvazioni che hanno ottenuto sia i suoi prodotti che il suo Sistema Qualità, sono la conferma del costante impegno di **Riviera srl Genova** alla ricerca della qualità e affidabilità nella sua produzione.

La bussola magnetica, strumento indispensabile per la navigazione sia costiera che d'altura, prodotta da **Riviera srl Genova** offre una serie di requisiti che sono di fondamentale importanza quali la grande facilità di lettura della rosa graduata, compensazione magnetica e mantenimento delle prestazioni in condizioni climatiche variabili, riparabilità di qualunque parte possa essere danneggiata.

La produzione di Riviera srl Genova consta, oltre alle sopracitate bussole magnetiche, di una serie di accessori nautici quali:

- timonerie meccaniche con relativi cavi di trasmissione;
- timonerie idrauliche per motori fuoribordo ed entrobordeo;
- leve elettroniche disponibili nella versione completamente gestita da componenti elettronici o nella versione elettropneumatica che le permettono di essere compatibili con qualsiasi tipologia di motore;
- monoleve e bileve a cruscotto;
- altoparlanti amagnetici e impermeabili;
- volanti;
- cavi controllo motore;
- tubazioni benzina;
- pompe benzina e accessori collegamento motori fuoribordo;
- chiavette di sicurezza motori fuoribordo;
- serbatoi benzina;

Questa serie di articoli viene progettata, prodotta e commercializzata da **Riviera srl Genova**, che ne garantisce la qualità e l'affidabilità nel tempo.

Riviera srl Genova has been designing and manufacturing quality magnetic compasses and nautical instruments in Italy since 1976 and exporting worldwide.

Riviera srl Genova, with its constant developments, has achieved reliable and Technically up-to-date products, always following the maritime tradition of simplicity and practical use.

These kinds of efforts have made Riviera products suitable for both leisure and commercial use whether you venture offshore or stay near the coast.

Riviera has obtained European Certifications and Approvals both of products and quality systems, so the results of the constant work of the Riviera team are always quality and reliable products.

Riviera magnetic compasses offer a series of essential features as:

- outstanding legibility of the card,
- magnetic compensation,
- reliable performance whatever the weather conditions.

We also offer our repair service: we can repair any damaged compass part, after sending you a quotation for the necessary repairs.

Riviera accessories and spares:

- mechanical steering systems with cables,
- outboard and inboard hydraulic steering systems,
- electronic levers,
- electro pneumatic levers suitable for any type of engines,
- single lever and two lever top mount controls,
- steering wheels,
- engine control cables,
- waterproof non-magnetic speakers,
- fuel hose,
- fuel pumps and outboard engine connectors,
- security stop keys for outboard engines,
- fuel tanks.

Riviera srl guarantees the quality and reliability of all the company's products.

AREA DI PRESENZA NEL MONDO AREA OF PRESENCE IN THE WORLD

L'azienda è presente nei principali mercati mondiali, l'elenco completo dei distributori è presente sul sito:

www.rivieragenova.com.

The company is present in the main worldwide markets, the complete list of the distributors is present on the web site:

www.rivieragenova.com.

AREA DI PRESENZA IN ITALIA AREA OF PRESENCE IN ITALY

Attualmente Riviera srl Genova copre il territorio nazionale con una rete vendita composta da Agenti aziendali qualificati ed introdotti nel settore, l'elenco completo dei distributori è presente sul sito:

www.rivieragenova.com.

Currently Riviera srl Genoa covers the national territory with a net sale composed by qualified business Agents and introduced in the sector, the complete list of the distributors is present on the web site:

www.rivieragenova.com.

DOVE SIAMO WHERE WE ARE



COME RAGGIUNGERCI HOW TO REACH US

Uscita GE-EST: indicazione a sinistra per Piacenza, proseguire per 3 Km.

Uscita GE-OVEST: indicazione Centro Città Km 10.

Exit GE-EST: Left indication for S.S 45 Piacenza, continue for 3 Km.

Exit GE-OVEST: City center indication Km 10.



UFFICIO TECNICO
RESEARCH AND DEVELOPMENT DEPT.

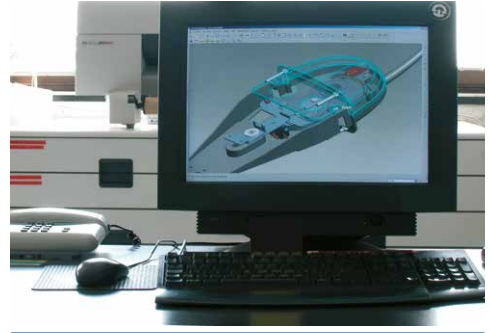

UFFICIO TECNICO
RESEARCH AND DEVELOPMENT DEPT.



REPARTO PROGETTAZIONI STAMPI
MOULD PLANNING DEPT.



REPARTO COSTRUZIONE STAMPI
MOULD MANUFACTURING DEPT.



REPARTO COSTRUZIONE STAMPI
MOULD MANUFACTURING DEPT.



REPARTO STAMPAGGIO
MOULDING DEPT.



REPARTO STAMPAGGIO
MOULDING DEPT.



REPARTO PRODUZIONE TIMONERIE
STEERING PRODUCTION DEPT.

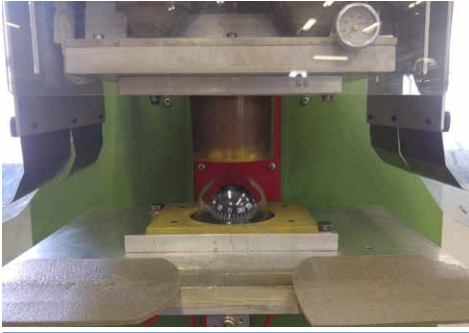

REPARTO PRODUZIONE BUSSOLE
COMPASSES PRODUCTION DEPT.



REPARTO PRODUZIONE BUSSOLE
COMPASSES PRODUCTION DEPT.



REPARTO PRODUZIONE ALTOPARLANTI
SPEAKERS PRODUCTION DEPT.



REPARTO PRODUZIONE CAVI
STEERING CABLES PRODUCTION DEPT.



LINEA PER PRODUZIONE TUBI
PIPES PRODUCTION LINE



CONTROLLO QUALITA'
QUALITY CONTROL



CONTROLLO QUALITA'
QUALITY CONTROL



MAGAZZINO PARTENZE
WAREHOUSE GOODS IN DEPARTURES

Riviera è presente in varie esposizioni del settore in Italia e nel mondo.
Riviera is present in various exhibitions of the nautical sector in Italy and in the world.

Salone Nautico Cannes / Yachting Festival Cannes

Salone Nautico Amsterdam / Mets Amsterdam

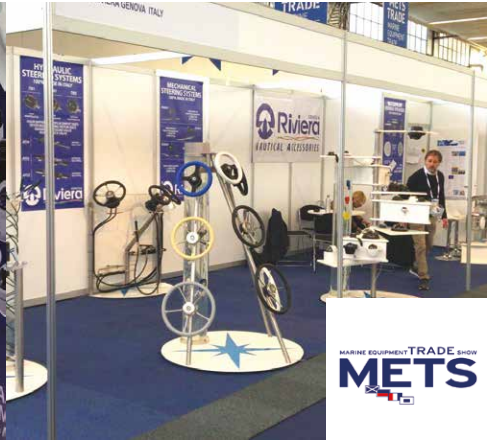

**YACHTING
FESTIVAL**
CANNES

NAUTICAL EQUIPMENT TRADE SHOW
METS

Salone Nautico Dusseldorf / Boot Dusseldorf

Salone Nautico Dubai / Dubai international Show



boot
Düsseldorf

معارض دبي
العالمية للقوارب
**DUBAI INTERNATIONAL
BOAT SHOW**

Salone Nautico Shanghai / Shanghai International Boat Show

Salone Nautico Genova / Genoa Boat Show



21st

Sin
International

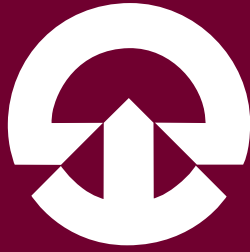

Riviera

SISTEMI AUDIO
AUDIO SYSTEM

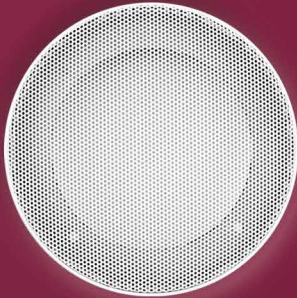

AUDIO SYSTEMS



RIVIERA BLUETOOTH SOUND SYSTEMS



Sviluppato da **Riviera** costituisce l'ultima evoluzione nel campo del Sea Sound. Consapevoli che ormai tutti possiedono almeno uno smartphone, un tablet e/o un pc è possibile diffondere la vostra musica nell'imbarcazione sfruttando il protocollo dati Bluetooth. Basta quindi con buchi sulla plancia di comando per incassare autoradio o touch panel, cablaggi e accessori: installare richiederà un tempo minimo e vi permetterà di ascoltare i vostri brani preferiti con un suono profondo e pulito, grazie ai suoi 80 Watt RMS per canale e la possibilità di collegare fino a 8 altoparlanti (4 Ohm) tra canale sinistro e destro; oppure creare una connessione con 4 altoparlanti e installare un Subwoofer per bassi potenti e profondi. I controlli integrati sul pannello del permettono di regolare ed equalizzare la qualità del suono.

Riviera bluetooth sound system R904 developed by Riviera is the latest evolution in the field of Sea Sound. Aware that by now everyone has at least a smartphone, tablet and/or a PC, you can listen to your music on the boat using the Bluetooth protocol data. Stop with holes on the control panel building-in touch panel, car radio, wiring and accessories: install the will require minimal time and will allow you to listen to your favorite songs with a deep and clean sound, thanks to its 80 Watt RMS for channel and the ability to connect up to 8 speakers (4 Ohm) between left and right channels; or you can create a connection with 4 speakers and install a Subwoofer for powerful and deep bass. The builtin controls on the panel of the Boat Amplifier R904 allow you to adjust and equalize the sound quality.

Fino a 4 casse da 120/200 w + 1 subwoofer 140w

Up to 4 casse 120/ 200 + 1 subwoofer 140w

400W Riviera Bluetooth Sound System



CODICI ORDINAZIONE / ORDER CODES 62.00787.00

KIT: 2 casse 200W + **R904** amplificatore bluetooth

KIT: 2x 200W speakers + **R904** Bluetooth amplifier

240W Riviera Bluetooth Sound System

CODICI ORDINAZIONE / ORDER CODES 62.00786.00

KIT: 2 casse 120W amagnetiche + **R904** amplificatore bluetooth

KIT: 2x 120W non-magnetic speakers + **R904** Bluetooth amplifier

Riviera Bluetooth Amplifier

R904 CARATTERISTICHE GENERALI / STANDARD FEATURES

80Wx4	Impedenza 4 Ohm e tensione di alimentazione 14.4V .Watt RMS	4 ohm load RMS power at 14.4V
120Wx4	Impedenza 2 Ohm e tensione di alimentazione 14.4V .Watt RMS	2 ohm load RMS power at 14.4V
230Wx2	Impedenza 4 Ohm connessione a ponte e tensione di alimentazione	4 ohms load bridged RMS power at 14.4V
0.2~5	Livello del segnale in ingresso	Input Level
10~35KHz	Risposta in Frequenza	Frequency response
<0.1%	Distorsione armonica al 30% di potenza	THD at 4 ohm load 30% rated power
2Ω	Minimo Impedenza di uscita	The minimum load
Y	Protezione al sovraccarico e sovratemperatura	Overload and Overheating protection
Y	Terminali placati oro	Independent gold plated terminals
320x188x56	Dimensioni	Product size(mm)



CODICI ORDINAZIONE / ORDER CODES 62.00788.00

R904 Amplificatore Bluetooth

R904 Bluetooth amplifier



Altoparlanti impermeabili / *Waterproof Loudspeakers*

200W

CARATTERISTICHE / KEY FEATURES

Impermeabili	Waterproof
Due Vie - (Twitter)	2 Ways - (Twitter)
Magnetico	Magnetic
Mascherina	Grill anti UV
Ferrite	Ferrite
Fornito a coppie	Sold in pairs
Prodotto artigianale fabbricato in Italia	Handcrafted product made in Italy
Garanzia 2 anni	Warranty 2 years

Sospensione in gomma trattata - Supporti delle bobine in Kapton - Cestello in Ixef
 Terminali placcati oro - Viti di montaggio in acciaio inox
Treated rubber Suspension - Kapton Coil supports - Ixef cone - Gold plated Terminals
Stainless steel screws - Impedenza/Impedance 4 Ohm

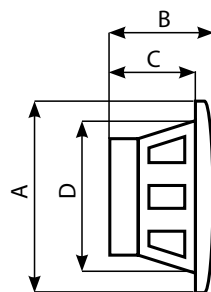

Diametro esterno
External Diameter **ø195 mm**



CODICI ORDINAZIONE / ORDER CODES

	Tipo/Type	W	DB	RIS. Hz	Kg	Mascherina/Grill	A	B	C	D
62.00797.00	Due vie/2 ways	200	93	50-20000	1,40	Bianca/White	195	85	68	142

Diametro esterno
External Diameter **ø172 mm**



CODICI ORDINAZIONE / ORDER CODES

	Tipo/Type	W	DB	RIS. Hz	Kg	Mascherina/Grill	A	B	C	D
62.00741.00	Due vie/2 ways	200	93	50-20000	1,40	Bianca/White	172	85	68	142
62.00741.10	Due vie/2 ways	200	93	50-20000	1,40	Carbonio/Carbon	172	85	68	142
62.00741.20	Due vie/2 ways	200	93	50-20000	1,40	Radica/Briar-root	172	85	68	142



Bianca / White



Carbonio / Carbon



Radica / Briar-root



Bianca / White



Subwoofer

CARATTERISTICHE / KEY FEATURES

Impermeabili	Waterproof
Impedenza 4 Ohm	Impedance 4 Ohm
Magnetico	Magnetic
Ferrite	Ferrite
Fornito singolo	Sold as single unit
Prodotto artigianale fabbricato in Italia	Handcrafted product made in Italy
Garanzia 2 anni	Warranty 2 years

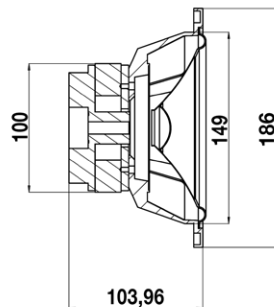

Sospensione in gomma trattata - Supporti delle bobine in Kapton - Cestello in Ixef
 Terminali placcati oro - Viti di montaggio in acciaio inox
Treated rubber Suspension - Kapton Coil supports - Ixef cone - Gold plated Terminals
Stainless steel screws - Impedenza/Impedance 4 Ohm

Diametro esterno
External Diameter **ø160 mm**



CODICI ORDINAZIONE / ORDER CODES

Ferrite

	Tipo/Type	W	DB	RIS. Hz	Kg	ohm
62.00743.00	Sub/Sub	140	92	50-20000	2,0	4

Cover



CARATTERISTICHE / KEY FEATURES

Copertura impermeabile per autoradio	Waterproof cover case
Resistente ai raggi UV	UV resistant
Resistente agli urti	Shock resistant

CODICI ORDINAZIONE / ORDER CODES

62.00505.00 Bianco/White

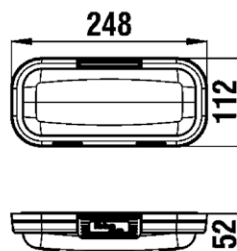



Altoparlanti impermeabili / *Waterproof Loudspeakers*

120W

CARATTERISTICHE / KEY FEATURES

Impedenza	Impedance 4 Ohm
Due Vie	2 Ways - (Twitter)
Amagnetico	Non-Magnetic
Mascherina	Grill anti UV
Neodimio	Neodymium - Ferrite
Fornito a coppie	Sold in pairs
Prodotto artigianale fabbricato in Italia	Handcrafted product made in Italy
Garanzia 2 anni	Warranty 2 years

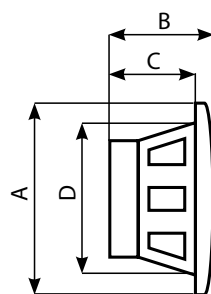

Sospensione in gomma trattata - Supporti delle bobine in Kapton - Cestello in Ixef
 Terminali placcati oro - Viti di montaggio in acciaio inox
Treated rubber Suspension - Kapton Coil supports - Ixef cone - Gold plated Terminals
Stainless steel screws - Impedenza/Impedance 4 Ohm

Diametro esterno **Ø195 mm**
External Diameter



CODICI ORDINAZIONE / ORDER CODES

Neodimio / *Neodymium*

	Tipo/Type	W	DB	RIS. Hz	Kg	Mascherina/Grill	A	B	C	D
62.00793.00	Due vie/2 ways	120	90	60-20000	0,547	Bianca/White	195	73	53	142

CODICI ORDINAZIONE / ORDER CODES

Ferrite

	Tipo/Type	W	DB	RIS. Hz	Kg	Mascherina/Grill	A	B	C	D
62.00796.00	Due vie/2 ways	120	90	50-20000	0,895	Bianca/White	195	83	67	142

Diametro esterno **Ø172 mm**
External Diameter



CODICI ORDINAZIONE / ORDER CODES

Neodimio / *Neodymium*

	Tipo/Type	W	DB	RIS. Hz	Kg	Mascherina/Grill	A	B	C	D
62.00428.01	Due vie/2 ways	120	90	60-20000	0,547	Bianca/White	172	70	53	142
62.00428.10	Due vie/2 ways	120	90	60-20000	0,547	Carbonio/Carbon	172	70	53	142
62.00428.20	Due vie/2 ways	120	90	60-20000	0,547	Radica/Briar-root	172	70	53	142



Diametro esterno
External Diameter **ø172 mm**



CODICI ORDINAZIONE / ORDER CODES

Ferrite

	Tipo/Type	W	DB	RIS. Hz	Kg	Mascherina/Grill	A	B	C	D
62.00424.01	Due vie/2 ways	120	90	50-20000	0,895	Bianca/White	172	80	67	142
62.00424.10	Due vie/2 ways	120	90	50-20000	0,895	Carbonio/Carbon	172	80	67	142
62.00424.20	Due vie/2 ways	120	90	50-20000	0,895	Radica/Briar-root	172	80	67	142
62.00424.30	Due vie/2 ways	120	90	50-20000	0,895	Metallo/Metal	172	80	67	142

Diametro esterno
External Diameter **ø160 mm**



CODICI ORDINAZIONE / ORDER CODES

Ferrite

	Tipo/Type	W	DB	RIS. Hz	Kg	Mascherina/Grill	A	B	C	D
62.00842.00	Due vie/2 ways	120	90	50-20000	0,867	Bianca/White	160	85	62	113

Diametro esterno
External Diameter **ø140 mm**



CODICI ORDINAZIONE / ORDER CODES

Ferrite

	Tipo/Type	W	DB	RIS. Hz	Kg	Mascherina/Grill	A	B	C	D
62.00426.01	Due vie/2 ways	120	90	50-20000	0,867	Bianca/White	140	82	62	113
62.00426.10	Due vie/2 ways	120	90	50-20000	0,867	Carbonio/Carbon	140	82	62	113
62.00426.20	Due vie/2 ways	120	90	50-20000	0,867	Radica/Briar-root	140	82	62	113



Bianca / White



Carbonio / Carbon



Radica / Briar-root



Bianca / White

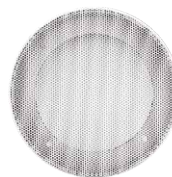

Metallo solo al coperto
Metal only for cabin in dor



Altoparlanti impermeabili / *Waterproof Loudspeakers*

80W

CARATTERISTICHE / KEY FEATURES

Altoparlanti impermeabili	<i>Waterproof Loudspeakers</i>
Impedenza	Impedance 4 Ohm
Dual cone	Doppio cono
Amagnetico	Non-Magnetic
Mascherina	grill anti UV
Neodimio	Neodymium
Standard	Slim
Fornito a coppie	Sold in pairs
Prodotto artigianale fabbricato in Italia	Handcrafted product made in Italy
Garanzia 2 anni	Warranty 2 years
Sospensione in gomma trattata - Supporti delle bobine in Kapton - Cestello in Ixef	
Terminali placcati oro - Viti di montaggio in acciaio inox	
<i>Treated rubber Suspension - Kapton Coil supports - Ixef cone - Gold plated Terminals</i>	
Stainless steel screws - Impedenza/Impedance 4 Ohm	

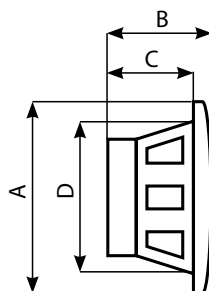

Diametro esterno
External Diameter **ø195 mm**



CODICI ORDINAZIONE / ORDER CODES

Neodimio / *Neodymium*

Slim

Tipo/Type	W	DB	RIS. Hz	Kg	Mascherina/Grill	A	B	C	D
62.00792.00 Doppio cono/ <i>Dual cone</i>	80	89	55-16000	0,700	Bianca/ <i>White</i>	195	50	30	145

CODICI ORDINAZIONE / ORDER CODES

Ferrite

STD

Tipo/Type	W	DB	RIS. Hz	Kg	Mascherina/Grill	A	B	C	D
62.00795.00 Doppio cono/ <i>Dual cone</i>	80	89	55-16000	0,893	Bianca/ <i>White</i>	195	83	67	142

Diametro esterno
External Diameter **ø172 mm**



CODICI ORDINAZIONE / ORDER CODES

Neodimio / *Neodymium*

Slim

Tipo/Type	W	DB	RIS. Hz	Kg	Mascherina/Grill	A	B	C	D
62.00628.00 Doppio cono/ <i>Dual cone</i>	80	89	60-16000	0,700	Bianca/ <i>White</i>	172	50	30	145
62.00628.10 Doppio cono/ <i>Dual cone</i>	80	89	60-16000	0,700	Carbonio/ <i>Carbon</i>	172	50	30	145
62.00628.20 Doppio cono/ <i>Dual cone</i>	80	89	60-16000	0,700	Radica/ <i>Briar-root</i>	172	50	30	145
62.00629.00 Doppio cono/ <i>Dual cone</i>	80	89	60-16000	0,700	Metallo/ <i>Metal</i>	183	49	30	145

CODICI ORDINAZIONE / ORDER CODES

Ferrite

STD

Tipo/Type	W	DB	RIS. Hz	Kg	Mascherina/Grill	A	B	C	D
62.00423.01 Doppio cono/ <i>Dual cone</i>	80	90	55-16000	0,893	Bianca/ <i>White</i>	172	80	67	142
62.00423.10 Doppio cono/ <i>Dual cone</i>	80	90	55-16000	0,893	Carbonio/ <i>Carbon</i>	172	80	67	142
62.00423.20 Doppio cono/ <i>Dual cone</i>	80	90	55-16000	0,893	Radica/ <i>Briar-root</i>	172	80	67	142



Diametro esterno
External Diameter **ø160 mm**



CODICI ORDINAZIONE / ORDER CODES

Neodimio / *Neodymium*

Tipo/Type	W	DB	RIS. Hz	Kg	Mascherina/Grill	A	B	C	D
62.00798.00 Doppio cono/ <i>Dual cone</i>	80	90	55-16000	0,505	Bianca/ <i>White</i>	160	73	52	113

CODICI ORDINAZIONE / ORDER CODES

Ferrite

Tipo/Type	W	DB	RIS. Hz	Kg	Mascherina/Grill	A	B	C	D
62.00799.00 Doppio cono/ <i>Dual cone</i>	80	90	55-16000	0,864	Bianca/ <i>White</i>	160	85	62	113

Diametro esterno
External Diameter **ø140 mm**



CODICI ORDINAZIONE / ORDER CODES

Neodimio / *Neodymium*

Tipo/Type	W	DB	RIS. Hz	Kg	Mascherina/Grill	A	B	C	D
62.00429.01 Doppio cono/ <i>Dual cone</i>	80	89	60-16000	0,700	Bianca/ <i>White</i>	140	70	52	113
62.00429.10 Doppio cono/ <i>Dual cone</i>	80	89	60-16000	0,700	Carbonio/ <i>Carbon</i>	140	70	52	113
62.00429.20 Doppio cono/ <i>Dual cone</i>	80	89	60-16000	0,700	Radica/ <i>Briar-root</i>	140	70	52	113

CODICI ORDINAZIONE / ORDER CODES

Ferrite

Tipo/Type	W	DB	RIS. Hz	Kg	Mascherina/Grill	A	B	C	D
62.00425.01 Doppio cono/ <i>Dual cone</i>	80	90	55-16000	0,893	Bianca/ <i>White</i>	140	82	62	113
62.00425.10 Doppio cono/ <i>Dual cone</i>	80	90	55-16000	0,893	Carbonio/ <i>Carbon</i>	140	82	62	113
62.00425.20 Doppio cono/ <i>Dual cone</i>	80	90	55-16000	0,893	Radica/ <i>Briar-root</i>	140	82	62	113



Bianca / *White*



Carbonio / *Carbon*



Radica / *Briar-root*



Bianca / *White*



Metallo solo al coperto
Metal only for cabin in door



Altoparlanti impermeabili / *Waterproof Loudspeakers*

60W & 10W

Altoparlanti impermeabili

Impedenza

Due vie

Amagnetico

Mascherina bianca

Ferrite

Fornito singolo

prodotto artigianale fabbricato in Italia

Garanzia 2 anni

Waterproof Loudspeakers

Impedance 4 - 8 Ohm

2 Ways - Dual cone

Non-Magnetic

White grill anti UV

Ferrite

Sold as single unit

Handcrafted product made in Italy

Warranty 2 years

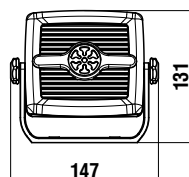
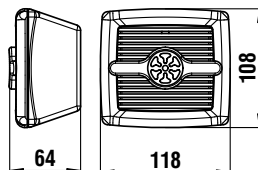

Sospensione in gomma trattata - Supporti delle bobine in Kapton - Cestello in Ixef

Terminali placcati oro - Viti di montaggio in acciaio inox

Treated rubber Suspension - Kapton Coil supports - Ixef cone - Gold plated Terminals

Stainless steel screws - Impedenza/Impedance 4 Ohm

Montaggio Incasso - Dim. esterne

Flush mount - External

118 mm x 108 mm (h)

CODICI ORDINAZIONE / *ORDER CODES*

	Tipo/ <i>Type</i>	W	DB	RIS. Hz	Kg	Mascherina/ <i>Grill</i>	ohm
62.00350.01	Doppio cono/ <i>Dual cone</i>	10	88	80-18000	0,661	Bianca nati UV/ <i>White anti UV</i>	4
62.00352.01	Doppio cono/ <i>Dual cone</i>	10	88	80-18000	0,661	Bianca nati UV/ <i>White anti UV</i>	8
62.00336.01	Doppio cono/ <i>Dual cone</i>	60	88	80-18000	0,665	Bianca nati UV/ <i>White anti UV</i>	4
62.00338.01	Due vie/ <i>2 ways</i>	60	89	80-20000	0,665	Bianca nati UV/ <i>White anti UV</i>	4

Montaggio a staffa - Dim. esterne

Bracket Mount - External

147 mm x 131 mm (h)

CODICI ORDINAZIONE / *ORDER CODES*

	Tipo/ <i>Type</i>	W	DB	RIS. Hz	Kg	Mascherina/ <i>Grill</i>	ohm
62.00350.10	Doppio cono/ <i>Dual cone</i>	10	88	80-18000	0,661	Bianca nati UV/ <i>White anti UV</i>	4
62.00352.10	Doppio cono/ <i>Dual cone</i>	10	88	80-18000	0,661	Bianca nati UV/ <i>White anti UV</i>	8
62.00336.10	Doppio cono/ <i>Dual cone</i>	60	88	80-18000	0,665	Bianca nati UV/ <i>White anti UV</i>	4
62.00338.10	Due vie/ <i>2 ways</i>	60	89	80-20000	0,665	Bianca nati UV/ <i>White anti UV</i>	4



Installazione a staffa / *Bracket mount*



Box ad incasso / *Flush mount*



Riviera

SISTEMI DI GUIDA MECCANICI
MECHANICAL STEERING SYSTEMS

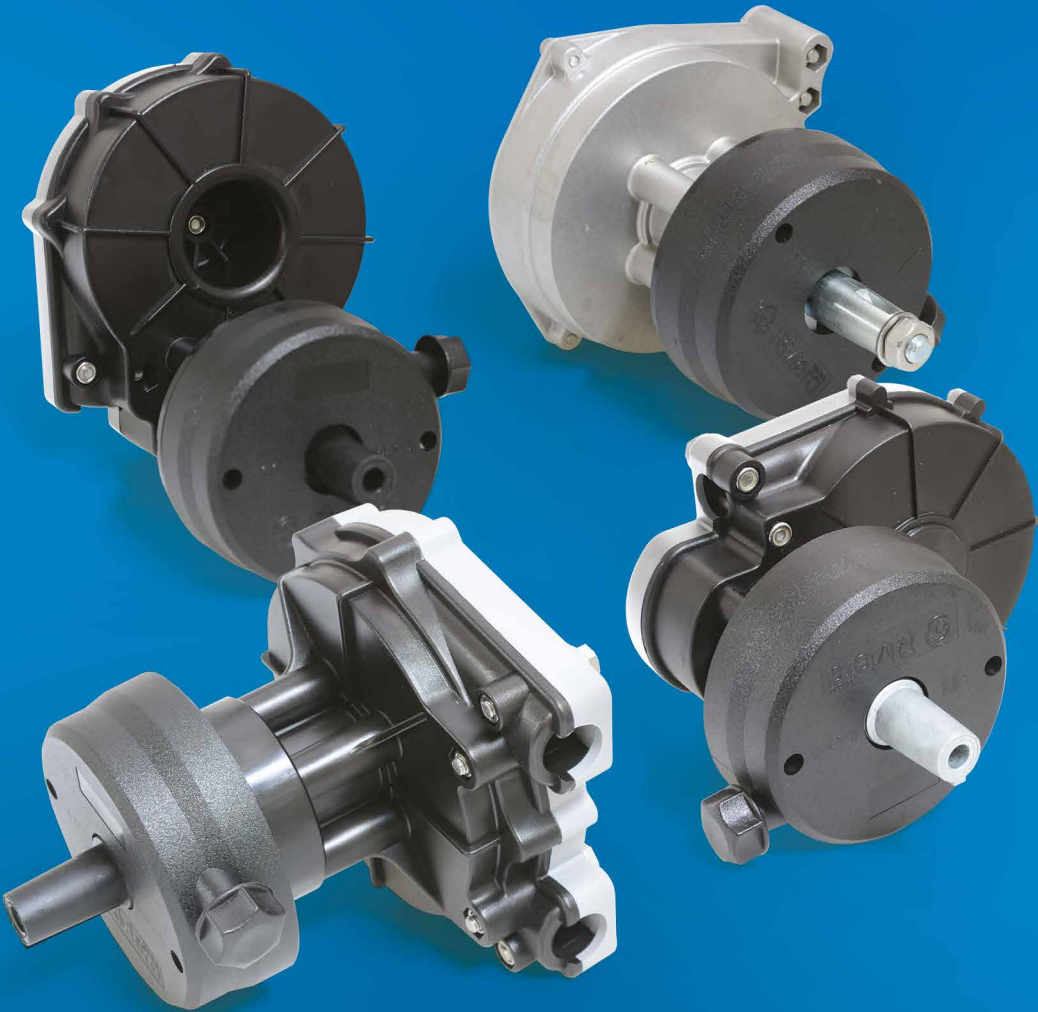

MECHANICAL STEERING SYSTEMS



COME SCEGLIERE IL SISTEMA DI GUIDA CON TIMONERIA MECCANICA

modalità eaccorgimenti per la scelta della vostratimoneria meccanica

La scelta dell'appropriato sistema di timoneria meccanica è un fattore essenziale per la sicurezza. L'esatta combinazione tra i tipi di forza generate dal tipo di scafo, dalla potenza del motore e dalla velocità della barca: sono determinanti per la scelta corretta oltre che per la sicurezza e l'ottimo funzionamento del sistema.

I motori entro bordo e entrofuoribordo non assistiti, unitamente ad uno scafo di grandi dimensioni, possono generare carichi di forza imponenti sul timone provocando una mancanza di sensibilità sul volante e una scarsa efficienza in termini di risposta alla guida pregiudicando la sicurezza di chi è a bordo; il suggerimento che **RIVIERA S.r.l. GENOVA** propone è quello di montare una delle sue timonerie meccaniche.

Le forze che si generano sulla timoneria e di conseguenza sull'organo di direzione che è il volante, affaticandone la guida e peggiorandone la maneggevolezza, nascono da due fattori: la potenza del propulsore e la velocità dell'imbarcazione; consigliamo pertanto di rivolgersi a personale specializzato ed esperto per trovare il miglior connubio e far sì che l'installazione del prodotto sia eseguita a regola d'arte.

APPROPRIATE MECHANICAL STEERING SYSTEM SELECTION

suggestions and warnings when selecting a mechanical steering system

Selection of the appropriate mechanical steering system is an important factor for the safety and functionality of your boat. The combination of engine power, hull type and boat speed influence the correct selection of the steering system.

The load on the steering system increases with the boat speed and engine power; the torque generated by the propeller rotation in high power outboard applications can make it hard to steer.

*Big boats with displacement hulls and inboard or non power assisted stern drive engines, can generate high rudder loads: in these cases a mechanical steering system will be inadequate and we suggest the use of an **RIVIERA S.r.l. GENOVA** mechanical steering system. We always recommend consulting qualified personnel when selecting, installing and maintaining a steering system for your boat.*

VANTAGGI DEL SISTEMA PLANETARIO

Le timonerie meccaniche **Riviera**, **MDA100** in Delrin e **MDA100M** in metallo sono state progettate utilizzando il principio di funzionamento **Planetario**. Queste timonerie sono dotate di tre satelliti che compiono una rotazione intorno al proprio asse e contemporaneamente compiono una rivoluzione intorno all'asse centrale.

Il Sistema Planetario permette di distribuire lo sforzo di guida su tre denti dell'ingranaggio centrale suddividendo e bilanciando gli sforzi subiti dal sistema. Si ottiene così una più lunga durata del sistema, un'efficienza maggiore rispetto alle timonerie con un solo ingranaggio e una riduzione al minimo dei giochi causati da eccessivi consumi dei componenti.

ADVANTAGES OF A PLANETARY GEAR DESIGN

***Riviera** mechanical steering helms **MDA100** in Delrin material and **MDA100M** in metal as well use a **Planetary Gear Design**. A Planetary Gear Design has three satellite gears that rotate on their axis and at the same time rotate around the central helm axis. This allows for equal distribution of engine torque over three points of the central gear, dividing and balancing the system loads. The benefits of this special design are increased system longevity, increased efficiency and less engine feedback compared to single pinion gear helms.*

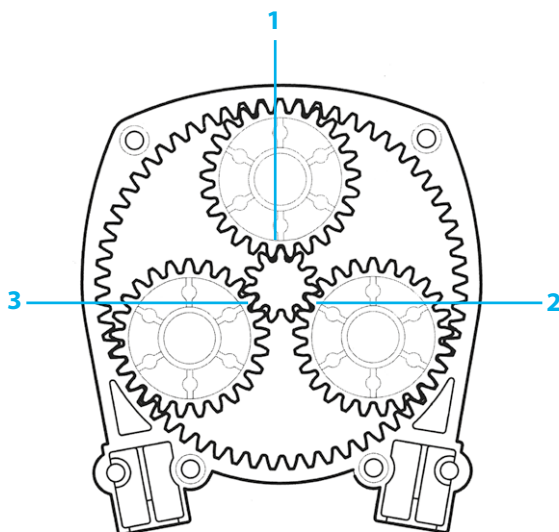



USO E MANUTENZIONE

Il monocavo della timoneria deve essere installato cercando di evitare percorsi tortuosi e curve troppo strette per consentire al guidatore di poter manovrare l'imbarcazione facilmente a tutte le velocità e per ridurre inefficienze e giochi nel sistema.

La corrosione causa il deterioramento dei materiali provocando una perdita dell'efficienza di manovra e, in casi estremi, la rottura del sistema stesso. Seguendo le specifiche fornite dai costruttori dei motori, i terminali del monocavo e il canotto del motore devono essere puliti e lubrificati periodicamente: con queste semplici operazioni si può minimizzare l'usura e la corrosione del sistema.



Il monocavo deve essere ispezionato periodicamente e regolarmente: se lo sforzo di guida dovesse aumentare o si rilevassero incisioni o tagli sulla protezione esterna della guaina o comunque danni ad altre sue componenti, si dovrà sostituirlo immediatamente.

Se si prevede di non utilizzare l'imbarcazione per un lungo periodo, raccomandiamo di togliere il terminale del monocavo dal canotto del motore e di pulirlo adeguatamente.

USE AND MAINTENANCE

The steering cable must be installed avoiding excessive and/or tight bends. This will provide the driver with easy handling at all speed, helping to reduce inefficiency and excess play in the system. Marine corrosion may cause the materials to deteriorate affecting maneuvering efficiency and in the worst case, system failure. By following the engine manufacturer specifications, the steering cable end fittings and the engine cable support must be cleaned and greased periodically; these simple operations minimize wear and corrosion in the system. The steering cable must be regularly inspected. If steering becomes hard, inconsistent, cuts on the conduit surface are noticed, or any other component found damaged, the cable must be replaced immediately. When storing your boat for an extended period of time we recommend removing the steering cable end fitting from its engine side support and cleaning it adequately.

GUIDA E RILEVAMENTO DELLA LUNGHEZZA DEL MONOCAVO SELECTION OF STEERING SYSTEMS AND CABLE LENGTH

APPLICAZIONI APPLICATION	POTENZA INSTALLATA ENGINE POWER	TIPO DI TIMONERIA STEERING SYSTEMS
FUORIBORDO / OUTBOARD	fino 45 HP up to 45HP	MD45
	LUNGHEZZA BARCA BOAT LENGTH fino a 30' (9m) up to 30' (9m)	MD100 MDA100 MDA100M
ENTROBORDO / INBOARD	fino a 35' (10.5m) up to 35' (10.5m)	MD100 MDA100 MDA100M
	ENTROFUORIBORDO / STERNDRIVE fino a 35' (10.5m) up to 35' (10.5m)	MDA100 MDA100M
		

Si raccomanda comunque di seguire sempre le indicazioni fornite dal costruttore del motore installato.
Always follow engine manufacturer's instructions.



COME RILEVARE LA LUNGHEZZA DEL MONOCAVO / PLANETARY GEAR DESIGN

Sommare A+B+C e togliere 10 cm per ciascuna curva del cavo a 90°.

Se il motore è dotato di tubo di fissaggio del monocavo, aggiungere 30,5 cm (1ft) alla lunghezza come sopra ottenuta. Per ottenere la lunghezza in piedi, dividere il risultato per 30,5 ed arrotondare al valore superiore.

Add. A + B + C and subtract 10 cm (4") for each 90° bend in the cable.

For installation through the engine tilt tube, add 30,5 cm (1 ft) to the measure calculated above.

To order in foot length, divide by 30,5 and round off to next whole foot.

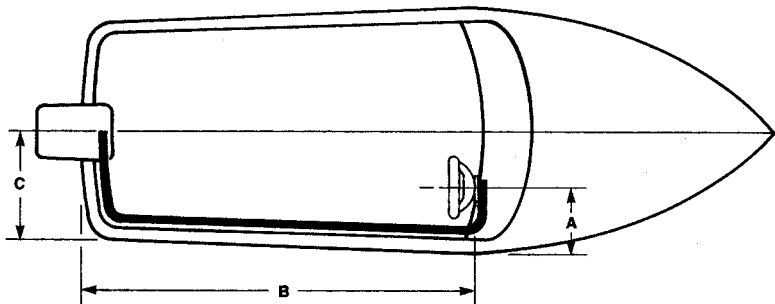

NELLE NUOVE INSTALLAZIONI: NEW STEERING CABLES INSTALLATION:

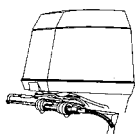

Fig. 1

FISSAGGIO ATTRAVERSO IL TUBO DEL MOTORE (Fig. 1)

Esempio (le misure sono in cm): A (50) + B (250) + C (80) = 380-20 per due curve a 90° = 360 + 30,5
Per fissaggio attraverso il tubo = 390,5 cm : 30,5 = 12,8 ft. arrotondare a 13 ft.

TILT TUBE MOUNTING (Fig. 1)

Example (dimensions in cm): A (50) + B (250) + C (80) = 380 - 20 for two 90° bends = 360 + 30,5
For a thru-tube installation 390,5 cm : 30,5 = 12,8 ft; round off to 13 ft

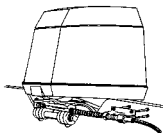

Fig. 2

FISSAGGIO CON STAFFA DI POPPA O A POZZETTO (FIG. 2)

Esempio (le misure sono in cm): A (50) + B (250) + C (80) = 380-20 per due curve a 90° = 360 cm: 30,5 = 11,8 ft arrotondare a 12 ft.

TRANSOM SUPPORT OR SPLASHWELL MOUNTING (FIG. 2)

Example (dimensions in cm): A (50) + B (250) + C (80) = 380 - 20 for two 90° bends = 360:30,5 = 11,8 ft; round off to 12 ft

COME RILEVARE LA LUNGHEZZA DEL MONOCAVO NEI RICAMBI HOW TO MEASURE FOR NEW STEERING CABLE INSTALLATION

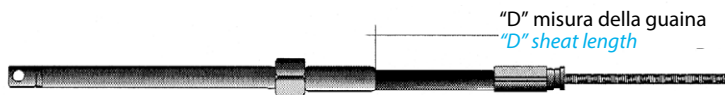

"D" misura della guaina
"D" sheat length

LUNGHEZZA DA ORDINARE: Misura "D" + 56 cm

Per ottenere la lunghezza in piedi, dividere il risultato per 30,5 e arrotondare al valore successivo.

Esempio: D= 305 cm + 56 cm= 361 : 30,5 = 11'8". Arrotondare a 12 ft.

ORDER LENGTH: "D" dimension + 56 cm

To order in foot length, divide for 30,5 and round up to the next whole foot

Example: D= 305 cm + 56 cm= 361 : 30,5 = 11'8". Round up to 12 ft

T01 (MD45) Monocavi di ricambio Replacement steering cables



TRASMISSIONE PER TIMONERIA MECCANICA / CONTROL CABLE FOR MECHANICAL STEERING HELM



Cert. di esame CE in accordo con le direttive 2013/53/EU

Cavo di comando tiro/spinta per timoneria meccanica.
Asta timone in acciaio inox.
Parti metalliche in ottone trattato.
Cavo spiralato diam. 6 mm.
Terminale filettato 10-32 UNF.
Raggio curvatura 200 mm.

Exam Certification CE according to the directive 2013/53/EU

Pull/push control cable suitable for all steering systems helm.
Stainless steel stock.
Treated brass metallic parts.
Spiral cable 6 mm.
Threaded terminal 10-32 UNF.
Steering cable bend ra- dius 200 mm.

CARATTERISTICHE / KEY FEATURES

Diametro guaina / Sheat diameter:	14 mm / 14 mm
Corsa / Stroke:	224 mm / 224 mm
Compatibilità / Suitable for:	Universale / Universal

CODICI ORDINAZIONE / ORDER CODES

62.00005.00 Indicare, al posto delle ultime due cifre, la lunghezza in piedi desiderata del cavo.
To order the right cable replace the last two number with the feet length required.

T02 (MD100 - MDA100 - MDA100M)

TRASMISSIONE PER TIMONERIA MECCANICA / CONTROL CABLE FOR MECHANICAL STEERING HELM



Cert. di esame CE in accordo con le direttive 2013/53/EU

Cavo di comando tiro/spinta per timoneria meccanica.
Terminali in acciaio inox.
Parti metalliche in ottone trattato.
Cavo spiralato diam. 8 mm.
Terminale filettato 10-32 UNF.
Raggio curvatura 200 mm.

Exam Certification CE according to the directive 2013/53/EU

Pull/push control cable suitable for all steering systems helm.
Stainless steel stock.
Treated brass metallic parts.
Spiral cable 8+ mm.
Threaded terminal 10-32 UNF.
Steering cable bend ra- dius 200 mm.

CARATTERISTICHE / KEY FEATURES

Diametro guaina / Sheat diameter:	16 mm / 16 mm
Corsa / Stroke:	224 mm / 224 mm
Compatibilità / Suitable for:	Universale / Universal

CODICI ORDINAZIONE / ORDER CODES

62.00356.00 Indicare, al posto delle ultime due cifre, la lunghezza in piedi desiderata del cavo.
To order the right cable replace the last two number with the feet length required.

T01

CODICI ORDINAZIONE / ORDER CODES 62.00005.00

PIEDI FEET	METRI METER	PIEDI FEET	METRI METER	PIEDI FEET	METRI METER
7	2,1346	19	5,7912	31	9,4488
8	2,4384	20	6,0960	32	9,7536
9	2,7432	21	6,4008	33	10,0584
10	3,0480	22	6,7056	34	10,3632
11	3,3528	23	7,0104	35	10,6680
12	3,6576	24	7,3152	36	10,9728
13	3,9624	25	7,6200	37	11,2776
14	4,2672	26	7,9248	38	11,5824
15	4,5720	27	8,2296	39	11,8872
16	4,8768	28	8,5344	40	12,1920
17	5,1816	29	8,8392		
18	5,4864	30	9,1440		

T02

CODICI ORDINAZIONE / ORDER CODES 62.00356.00

PIEDI FEET	METRI METER	PIEDI FEET	METRI METER	PIEDI FEET	METRI METER
7	2,1346	19	5,7912	31	9,4488
8	2,4384	20	6,0960	32	9,7536
9	2,7432	21	6,4008	33	10,0584
10	3,0480	22	6,7056	34	10,3632
11	3,3528	23	7,0104	35	10,6680
12	3,6576	24	7,3152	36	10,9728
13	3,9624	25	7,6200	37	11,2776
14	4,2672	26	7,9248	38	11,5824
15	4,5720	27	8,2296	39	11,8872
16	4,8768	28	8,5344	40	12,1920
17	5,1816	29	8,8392		
18	5,4864	30	9,1440		

Indicare al posto delle ultime due cifre, la lunghezza in piedi del cavo. Es: 62.00005.10 corrisponde al cavo tipo T01 da 10 piedi
For order indicate the code of cable follow to the length in feet and his description. Example: 62.00005.10 Cable T01 type length 10 feet



MD45 Scatole comando per timoneria meccanica Steering helm

NEW

Montaggio compatibile con la maggior parte delle timonerie meccaniche di altre marche
Mounting compatible with most mechanical steering systems of other brands

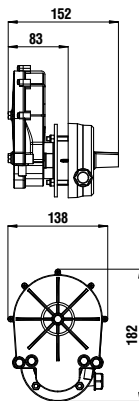

Cert. di esame CE in accordo con le direttive 2013/53/EU

Costruita interamente con materiali che consentono un'elevata resistenza meccanica e un'inalterabile resistenza all'usura e agli agenti atmosferici. Frizione regolabile tramite manopola esterna.

8 posizioni differenti per permettere l'uscita del cavo nella direzione più conveniente.

Utilizzare cavi T01

Exam Certification CE according to the directive 2013/53/EU

High Mechanical resistance. Corrosion resistant material.

Standard friction externally adjustable. Eight optional helm positions to facilitate steering cable installation.

Use cables T01

CARATTERISTICHE / KEY FEATURES

Installazione / <i>Installation:</i>	Incasso / <i>Flush mount</i>
Tipo ingranaggio / <i>Gearing:</i>	Semplice / <i>Standar design</i>
Potenza motore / <i>Engine power:</i>	Fino a 45HP / <i>Up to 45HP</i>
Applicazione / <i>Application:</i>	Fuoribordo fino a 30° (9m) / <i>Outboard uo to 30° (9m)</i>



CODICI ORDINAZIONE / **ORDER CODES**
62.00874.00

MD100 Scatole comando per timoneria meccanica Steering helm

NEW

Montaggio compatibile con la maggior parte delle timonerie meccaniche di altre marche
Mounting compatible with most mechanical steering systems of other brands

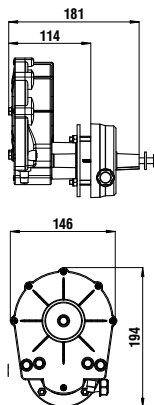

Cert. di esame CE in accordo con le direttive 2013/53/EU

Costruita interamente con materiali che consentono un'elevata resistenza meccanica e un'inalterabile resistenza all'usura e agli agenti atmosferici. Frizione regolabile tramite manopola esterna.

8 posizioni differenti per permettere l'uscita del cavo nella direzione più conveniente.

Utilizzare cavi T02

Exam Certification CE according to the directive 2013/53/EU

High Mechanical resistance. Corrosion resistant material.

Standard friction externally adjustable. Eight optional helm positions to facilitate steering cable installation.

Use cables T02

CARATTERISTICHE / KEY FEATURES

Installazione / <i>Installation:</i>	Incasso / <i>Flush mount</i>
Tipo ingranaggio / <i>Gearing:</i>	Semplice / <i>Standar design</i>
Potenza motore / <i>Engine power:</i>	Oltre i 45HP / <i>Over 45HP</i>
Applicazione / <i>Application:</i>	Fuoribordo fino a 30° (9m) / <i>Outboard uo to 30° (9m)</i> Entrobordo fino a 35° (10.5m) / <i>Inboard up to 35° (10.5m)</i>



CODICI ORDINAZIONE / **ORDER CODES**
62.00875.00

MDA100

Scatole comando per timoneria meccanica
Steering helm

NEW



Montaggio compatibile con la maggior parte delle timonerie meccaniche di altre marche
Mounting compatible with most mechanical steering systems of other brands

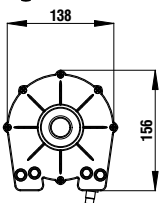
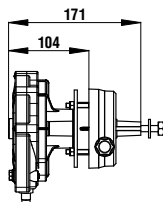
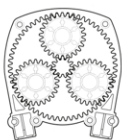

METALLO
METAL

Cert. di esame CE in accordo con le direttive 2013/53/EU

Costruita interamente con materiali che consentono un'elevata resistenza meccanica e un'inalterabile resistenza all'usura e agli agenti atmosferici. Frizione regolabile tramite manopola esterna. 8 posizioni differenti per permettere l'uscita del cavo nella direzione più conveniente.

Utilizzare cavi T02

Exam Certification CE according to the directive 2013/53/EU

High Mechanical resistance. Corrosion resistant material. Standard friction externally adjustable. Eight optional helm positions to facilitate steering cable installation. Use cables T02

CARATTERISTICHE / KEY FEATURES

Installazione / *Installation:*

Incasso / *Flush mount*

Tipo ingranaggio / *Gearing:*

A planetario / *Planetary design*

Potenza motore / *Engine power:*

Oltre i 45HP / *Over 45HP*

Applicazione / *Application:*

Fuoribordo fino a 30' (9m) / *Outboard up to 30' (9m)*

Entrobordo fino a 35' (10.5m) / *Inboard up to 35' (10.5m)*

Entrofuoribordo fino a 35' (10.5m) / *Sterndrive up to 35' (10.5m)*



CODICI ORDINAZIONE / ORDER CODES

62.00876.00

MDA100M

Scatole comando per timoneria meccanica
Steering helm

NEW

Montaggio compatibile con la maggior parte delle timonerie meccaniche di altre marche
Mounting compatible with most mechanical steering systems of other brands

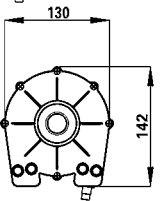
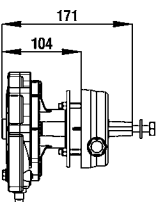
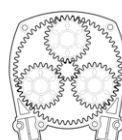

METALLO / METAL

Cert. di esame CE in accordo con le direttive 2013/53/EU

Costruita interamente con materiali che consentono un'elevata resistenza meccanica e un'inalterabile resistenza all'usura e agli agenti atmosferici. Frizione regolabile tramite manopola esterna. 8 posizioni differenti per permettere l'uscita del cavo nella direzione più conveniente.

Utilizzare cavi T02

Exam Certification CE according to the directive 2013/53/EU

High Mechanical resistance. Corrosion resistant material. Standard friction externally adjustable. Eight optional helm positions to facilitate steering cable installation. Use cables T02

CARATTERISTICHE / KEY FEATURES

Installazione / *Installation:*

Incasso / *Flush mount*

Tipo ingranaggio / *Gearing:*

A planetario / *Planetary design*

Potenza motore / *Engine power:*

Oltre i 45HP / *Over 45HP*

Applicazione / *Application:*

Fuoribordo fino a 30' (9m) / *Outboard up to 30' (9m)*

Entrobordo fino a 35' (10.5m) / *Inboard up to 35' (10.5m)*

Entrofuoribordo fino a 35' (10.5m) / *Sterndrive up to 35' (10.5m)*



CODICI ORDINAZIONE / ORDER CODES

62.0877.00



Riviera

**SISTEMI DI GUIDA MECCANICI:
KIT DI INSTALLAZIONE**
***MECHANICAL STEERING SYSTEMS:
INSTALLATION KIT***

MECHANICAL STEERING SYSTEMS



KMD45 Timoneria meccanica confezionato in kit Packaged mechanical steering system

Montaggio compatibile con la maggior parte delle timonerie meccaniche di altre marche
Mounting compatible with most mechanical steering systems of other brands



Adatto per un sistema di guida che comprende una timoneria e monocavo
Lungh. max cavo 20 piedi
Utilizzare cavi T01

Especially suitable for steering with one-helm and steering cable Max cable length 20 feet Use cables T01

CARATTERISTICHE / KEY FEATURES

Timoneria meccanica / <i>Steering helm:</i>	MD45 / MD45
Cavo telecomando / <i>Steering cable:</i>	T01 / T01
Potenza motore / <i>Engine power:</i>	Fino a 45HP / <i>Up to (45HP)</i>
Applicazione / <i>Application:</i>	Fuoribordo fino a 30' (9m) / <i>Outboard up to 30' (9m)</i>

KMD100 Timoneria meccanica confezionato in kit Packaged mechanical steering system

Montaggio compatibile con la maggior parte delle timonerie meccaniche di altre marche
Mounting compatible with most mechanical steering systems of other brands



Adatto per un sistema di guida che comprende una timoneria e monocavo
Lungh. max cavo 20 piedi
Utilizzare cavi T02

Especially suitable for steering with one helm and steering cable Max cable length 20 feet Use cables T02

CARATTERISTICHE / KEY FEATURES

Timoneria meccanica / <i>Steering helm:</i>	MD100 / MD100
Cavo telecomando / <i>Steering cable:</i>	T02 / T02
Potenza motore / <i>Engine power:</i>	Oltre i 45HP / <i>Over 45HP</i>
Applicazione / <i>Application:</i>	Fuoribordo fino a 30' (9m) / <i>Outboard up to 30' (9m)</i> Entrobordo fino a 35' (10.5m) / <i>Inboard up to 35' (10.5m)</i>

KMD45 con/with T01

CODICI ORDINAZIONE / *ORDER CODES*
62.00878.00

Indicare al posto delle ultime due cifre, la lunghezza in piedi del cavo.
Es: 62.00878.10 corrisponde al cavo tipo T01 da 10 piedi
For order indicate the code of cable follow to the length in feet and his description. For example: 62.00878.10 Cable T01 type length 10 feet

PIEDI <i>FEET</i>	METRI <i>METER</i>
7	2,1346
8	2,4384
9	2,7432

PIEDI <i>FEET</i>	METRI <i>METER</i>
10	3,0480
11	3,3528
12	3,6576

PIEDI <i>FEET</i>	METRI <i>METER</i>
13	3,9624
14	4,2672
15	4,5720

KMD100 con/with T02

CODICI ORDINAZIONE / *ORDER CODES*
62.00879.00

Indicare al posto delle ultime due cifre, la lunghezza in piedi del cavo.
Es: 62.00879.10 corrisponde al Kit con cavo T02 da 10 piedi
For order indicate the code of cable follow to the length in feet and his description. For example : 62.00879.10 Cable T02 type length 10 feet

PIEDI <i>FEET</i>	METRI <i>METER</i>
16	4,8768
17	5,1816
18	5,4864

PIEDI <i>FEET</i>	METRI <i>METER</i>
19	5,7912
20	6,0960



KMDA100 Timoneria meccanica confezionato in kit Packaged mechanical steering system

Montaggio compatibile con la maggior parte delle timonerie meccaniche di altre marche
Mounting compatible with most mechanical steering systems of other brands



**METALLO
METAL**



Adatto per un sistema di guida che comprende una timoneria e monocavo
Lungh. max cavo 20 piedi
Utilizzare cavi T02

Especially suitable for steering with one helm and steering cable
Max cable length 20 feet
Use cables T02

CARATTERISTICHE / KEY FEATURES

Timoneria meccanica / <i>Steering helm:</i>	MDA100 / MDA100
Cavo telecomando / <i>Steering cable:</i>	T02 / T02
Potenza motore / <i>Engine power:</i>	Oltre i 45HP / Over 45HP
Applicazione / <i>Application:</i>	Fuoribordo fino a 30' (9m) / Outboard up to 30' (9m) Entrobordo fino a 35' (10.5m) / Inboard up to 35' (10.5m) Entrofuoribordo fino a 35' (10.5m) / Sterndrive up to 35' (10.5m)

KMDA100M Timoneria meccanica confezionato in kit Packaged mechanical steering system

Montaggio compatibile con la maggior parte delle timonerie meccaniche di altre marche
Mounting compatible with most mechanical steering systems of other brands

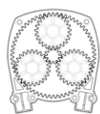

Adatto per un sistema di guida che comprende una timoneria e monocavo
Lungh. max cavo 20 piedi
Utilizzare cavi T02

Especially suitable for steering with one helm and steering cable
Max cable length 20 feet
Use cables T02

CARATTERISTICHE / KEY FEATURES

Timoneria meccanica / <i>Steering helm:</i>	MDA100M / MDA100M
Cavo telecomando / <i>Steering cable:</i>	T02 / T02
Potenza motore / <i>Engine power:</i>	Oltre i 45HP / Over 45HP
Applicazione / <i>Application:</i>	Fuoribordo fino a 30' (9m) / Outboard up to 30' (9m) Entrobordo fino a 35' (10.5m) / Inboard up to 35' (10.5m) Entrofuoribordo fino a 35' (10.5m) / Sterndrive up to 35' (10.5m)

KMDA100 con/with T02

CODICI ORDINAZIONE / ORDER CODES
62.00880.00

Indicare al posto delle ultime due cifre, la lunghezza in piedi del cavo.
Es: 62.00880.10 corrisponde al Kit con cavo T02 da 10 piedi
For order indicate the code of cable follow to the length in feet and his description. For example : 62.00880.10 Cable T02 type length 10 feet

KMDA100M con/with T02

CODICI ORDINAZIONE / ORDER CODES
62.00881.00

Indicare al posto delle ultime due cifre, la lunghezza in piedi del cavo.
Es: 62.00881.10 corrisponde al Kit con cavo T02 da 10 piedi
For order indicate the code of cable follow to the length in feet and his description. For example : 62.00881.10 Cable T02 type length 10 feet

PIEDI FEET	METRI METER	PIEDI FEET	METRI METER	PIEDI FEET	METRI METER	PIEDI FEET	METRI METER	PIEDI FEET	METRI METER
7	2,1346	10	3,0480	13	3,9624	16	4,8768	19	5,7912
8	2,4384	11	3,3528	14	4,2672	17	5,1816	20	6,0960
9	2,7432	12	3,6576	15	4,5720	18	5,4864		

ACCESSORI CAVI - Soffietti passaguia con cuffia in gomma CABLES ACCESSORIES - Polyurethane bellows for steering cables



DESCRIZIONE / DESCRIPTION

Soffietto bicono foro d.8. Q.tà minima 5 PZ.

Double cable bellows d.8. Minimum quantity 5 PCS.

COD. ORDINAZIONE / ORDER COD.

62.00380.01 Nero / Black
62.00380.02 Bianco / White
62.00380.03 Grigio / Grey

DESCRIZIONE / DESCRIPTION

Soffietto con flangia foro d.12. Q.tà minima 5 PZ.

Flanged bellows d.12. Minimum quantity 5 PCS.

COD. ORDINAZIONE / ORDER COD.

● **62.00381.01** Nero / Black
○ **62.00381.02** Bianco / White
● **62.00381.03** Grigio / Grey

DESCRIZIONE / DESCRIPTION

Soffietto con flangia foro d.12. Q.tà minima 5 PZ.

Flanged bellows d.12. Minimum quantity 5 PCS.

COD. ORDINAZIONE / ORDER COD.

● **62.00382.01** Nero / Black
○ **62.00382.02** Bianco / White
● **62.00382.03** Grigio / Grey

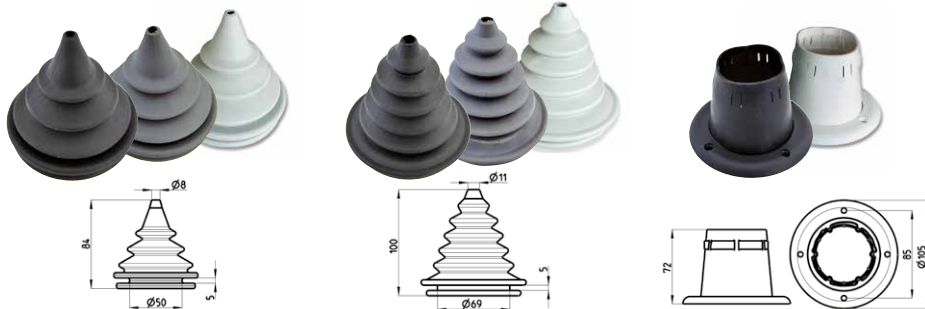

DESCRIZIONE / DESCRIPTION

Soffietto foro d.8. Q.tà minima 5 PZ.

Bellows d.8. Minimum quantity 5 PCS.

COD. ORDINAZIONE / ORDER COD.

62.00384.01 Nero / Black
62.00384.02 Bianco / White
62.00384.03 Grigio / Grey

DESCRIZIONE / DESCRIPTION

Soffietto foro d.11. Q.tà minima 5 PZ.

Bellows d.11. Minimum quantity 5 PCS.

COD. ORDINAZIONE / ORDER COD.

● **62.00387.01** Nero / Black
○ **62.00387.02** Bianco / White
● **62.00387.03** Grigio / Grey

DESCRIZIONE / DESCRIPTION

Soffietto con fascetta. Q.tà minima 5 PZ.

Bellows with clamp. Minimum quantity 5 PCS.

COD. ORDINAZIONE / ORDER COD.

● **62.00383.01** Nero / Black
○ **62.00383.02** Bianco / White

ACCESSORI TIMONERIE / STEERING ACCESSORIES

Snodo per cavi timonerie
Joint for steering cable

COD. ORDINAZIONE / ORDER COD.
62.00359.00



Adattatore per scatole UF.
Compatibile con cavo T01.
UF boxes adapter suitable for T01 cable

COD. ORDINAZIONE / ORDER COD.
62.00512.00



Snodo per cavi timonerie
+ staffa di supporto
Joint and bracket set for steering cable

COD. ORDINAZIONE / ORDER COD.
62.00362.00



Adattatore per montaggio
timoneria UF T71.
Compatibile cavo T02.
Assembly adapter for UF T71 suitable for T02

COD. ORDINAZIONE / ORDER COD.
62.00366.00





TUBI PASSACAVI / CABLES PASSAGE



Tubo grigio lunghezza 1,20 mt con raccordi neri
Grey hose 1,20 mt length with black fittings included

COD. ORDINAZIONE / ORDER COD.
62.00800.00



Tubo grigio lunghezza 0,80 mt con raccordi neri
Grey hose 0,80 mt length with black fittings included

COD. ORDINAZIONE / ORDER COD.
62.00800.04



Tubo grigio lunghezza 1,20 mt con raccordi bianchi
Grey hose e 1,20 mt length with white fittings included

COD. ORDINAZIONE / ORDER COD.
62.00800.10



Tubo grigio lunghezza 0,80 mt con raccordi bianchi
Grey hose 0,80 mt length with white fittings included

COD. ORDINAZIONE / ORDER COD.
62.00800.14



Tubo nero lunghezza 1,20 mt con raccordi neri
Black hose 1,20 mt length with black fittings included

COD. ORDINAZIONE / ORDER COD.
62.00802.00



Tubo nero lunghezza 0,80 mt con raccordi neri
Black hose 0,80 mt length with black fittings included

COD. ORDINAZIONE / ORDER COD.
62.00802.04



Tubo nero lunghezza 1,20 mt con raccordi bianchi
Black hose 1,20 mt length with white fittings included

COD. ORDINAZIONE / ORDER COD.
62.00802.10



Tubo nero lunghezza 0,80 mt con raccordi bianchi
Black hose 0,80 mt length with white fittings included

COD. ORDINAZIONE / ORDER COD.
62.00802.14



Tubo passacavo mt 20
Hose 20 mt length

COD. ORDINAZIONE
ORDER COD.

62.00800.03 Grigio / Grey
62.00802.03 Nero / Black



Tubo grigio lunghezza 0,80 mt con soffietto nero
Grey hose 0,80 mt length with black fittings

COD. ORDINAZIONE / ORDER COD.
62.00801.00



Tubo grigio lunghezza 0,80 mt con soffietto bianco
Grey hose 0,80 mt length with white fittings

COD. ORDINAZIONE / ORDER COD.
62.00801.10



Attacco flangia (conf. 10 PZ.)
Flange joint (10 pieces pac.)

COD. ORDINAZIONE
ORDER COD.
62.00800.11 Bianco / White
62.00800.01 Nero / Black



Attacco passacavo (conf. 10 PZ.)
Joint for cable (10 pieces pac.)

COD. ORDINAZIONE
ORDER COD.
62.00800.12 Bianco / White
62.00800.02 Nero / Black



Riviera

**SISTEMI DI GUIDA IDRAULICI
HYDRAULIC STEERING SYSTEMS**



HYDRAULIC STEERING SYSTEMS



STEERING SYSTEMS - PUMP/PISTON COUPLINGS



TABELLA ACCOPPIAMENTI POMPA/PISTONE PUMP/PISTON COUPLINGS

Cod. Pistone Cod. Piston	V. cc Vcc	Cod. Pompa Cod. Pump	N. Giri N. of turns	Cod. Pompa Cod. Pump	N. Giri N. of turns	Cod. Pompa Cod. Pump	N. Giri N. of turns	Cod. Pompa Cod. Pump	N. Giri N. of turns	Cod. Pompa Cod. Pump	N. Giri N. of turns	Cod. Pompa Cod. Pump	N. Giri N. of turns
62.00867.00	120	62.00600.00	4,3	62.00601.00	3,5	62.00602.00	3	62.00693.00	2,6	62.00694.00	2,1	62.00695.00	1,8
62.00868.00	120		4,3		3,5		3		2,6		2,1		1,8
62.00593.00	100		3,6		2,9		2,6		2,2		1,8		1,5
62.00583.00	141		5,0		4,1		3,6		3,1		2,5		2,1
62.00591.00	57		2,0		1,7		1,5		1,45		1,5		1,2
62.00584.00	116		4,1		3,4		3		3,0		2,4		2,0
62.00677.00	442		15,8		13,0		11,3		9,8		7,9		6,5
62.00679.00	530		18,9		15,6		13,6		11,8		9,5		7,8
62.00680.00	783		28,0		23,0		20,1		17,4		14,0		11,5
62.00702.00	236		8,4		6,9		6,1		5,2		4,2		3,5
62.00683.00	1130		40,4		33,2		29		25,1		20,2		16,6
62.00684.00	1530		54,6		45,0		39,3		34,0		27,3		22,5
62.00689.00	339		12,1		10,0		8,7		7,5		6,1		5,0
62.00690.00	442		15,8		13,0		11,3		9,8		7,9		6,5
62.00691.00	530		18,9		15,6		13,6		11,8		9,5		7,8
62.00692.00	783		28,0		23,0		20,1		17,4		14,0		11,5
62.00685.00	339		12,1		10,0		8,7		7,5		6,1		5,0
62.00686.00	445		15,9		13,1		11,4		9,9		7,9		6,5
62.00687.00	530		18,9		15,6		13,6		11,8		9,5		7,8
62.00688.00	783		28,0		23,0		20		17,4		14,0		11,5

Nota bene: gli accoppiamenti evidenziati sono sconsigliati.

Vengono indicati in tabella i volumi e i giri volante per le due direzioni. Per la scelta attenersi al n° di giri totale.

Note: the pair shown are not recommended.

They are given the volumes and the turns of steering wheel for the two directions in the table. For choosing to follow the number of total turns.



- **Struttura compatta**
Compact design
- **Sistema a pistoni assiali**
Bolt bearing pistons race
- **Dotate di valvola di non-ritorno che impedisce la reversibilità**
Built-in lock valve for positive rudder lock
- **Alberino conico da 3/4" in acciaio inossidabile**
3/4" conical stainless steel shaft
- **Valvola di non-ritorno e guarnizione alberino facilmente accessibili in caso di sostituzione**
Easy accessible lock valve and shaft seal for replacement
- **Rotore costruito in acciaio per una maggiore durata**
Elbow fitting helm
- **Complete di raccordi a gomito**
Cast-Iron cylinder block

PROPRIETÀ DEL SISTEMA DI GUIDA IDRAULICO

Il sistema di guida idraulico della barca è costituito da una pompa posta sul cruscotto, da un cilindro posizionato a poppa e collegato al timone o al motore e da due tubi idraulici di nylon di collegamento. Una rotazione del volante provoca il pompaggio dell'olio che, a seconda del senso di rotazione, affluisce, attraverso uno dei due tubi, ad una delle due camere del cilindro. Il conseguente movimento del pistone sposta il timone dell'imbarcazione cui è collegato lo stelo del cilindro. Le pompe sono dotate di una valvola che ha la funzione d'impedire il flusso dell'olio alla pompa se questa non viene azionata (VALVOLA DI NON RITORNO) ed inoltre rende possibile il funzionamento dei sistemi con due o più stazioni di guida. I cilindri sono a doppia azione e possono essere bilanciati o non bilanciati. I cilindri bilanciati richiedono lo stesso numero di giri del volante per spostare il timone da centro a fine corsa nelle due direzioni opposte.

HOW THE SYSTEM WORKS

A hydraulic steering system consists of a steering pump, a cylinder tied to the rudder or to the outboard or stern-drive engine and the connecting nylon or copper tubing. Under normal operating conditions, a turn of the steering wheel will pump the oil through one of the two connecting hydraulic lines into the cylinder's chamber either extending or retracting the cylinder rod. The fluid going out from the other chamber of the cylinder is returned to the helm via the other hydraulic line. There are two basic components in all the hydraulic steering systems: the helm unit and the cylinder, connected by nylon or copper tubing. The helm unit consists of both a hydraulic pump and a valve assembly. The valve assembly prevents outgoing fluid from returning along the same line, isolates each steering station, locks the rudder and eliminates rudder "feedback" to the helm. The cylinders are double acting and be balanced and the wheel needs the same number of turns for both sides.

SCELTA DI UN SISTEMA DI GUIDA IDRAULICO

Lo sforzo necessario per guidare un'imbarcazione dotata di un sistema di guida idraulico è inversamente proporzionale al numero di giri del volante da banda a banda. Il numero di giri del volante è determinato dal rapporto fra volume del cilindro, portata della pompa. A parità di cilindro applicato sul motore, minore è il numero di giri del volante, maggiore è lo sforzo per guidare essendo la guida più diretta, mentre con un numero maggiore di giri del volante la guida è demoltiplicata e quindi lo sforzo è inferiore. Altri fattori che influenzano lo sforzo necessario per guidare un'imbarcazione sono:

- La velocità dell'imbarcazione
- La dimensione del timone, o la potenza del motore
- Il tipo di scafo (planante, dislocante, ecc.)
- Le condizioni del mare
- Il tipo di olio utilizzato

SELECTION OF A HYDRAULIC STEERING SYSTEM

The strength required to drive a boat equipped with a hydraulic steering system is inversely proportional to the number of turns of the wheel lock-to-lock. The wheel turns are determined by the ratio between the cylinder volume and pump displacement. With the same type of cylinder installed on the engine, the less are the turns, the faster is the response but higher is the effort; more wheel turns, slower is the response and lower is the effort. Other factors that can influence steering effort are:

- Vessel speed
- Rudder dimension, or engine power
- Hull type (displacement, planing, etc.)
- Sea condition
- Oil type

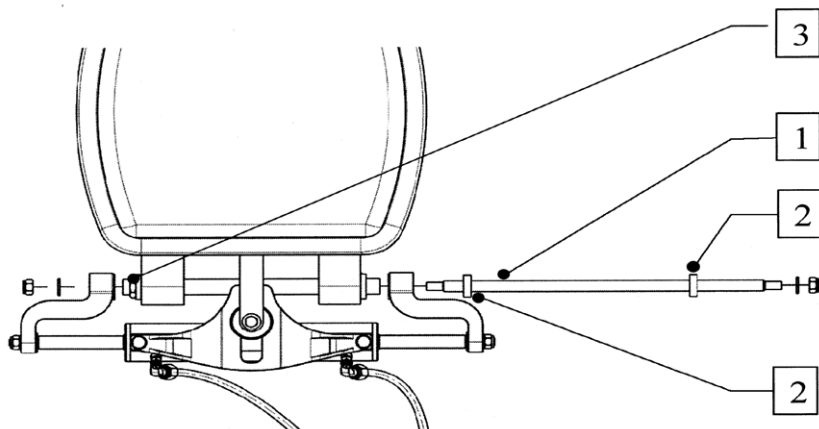

CILINDRI FUORIBORDO BILANCIATI DA DIPORTO

I cilindri fuoribordo bilanciati **NON** necessitano di supporti o sostegni da fissare allo scafo.

Collegare i tubi come mostrato in figura.

Collegare la barra del timone alla staffa mediante apposita viteria inclusa.

Assicurarsi che i raccordi per lo spurgo siano correttamente rivolti verso l'alto.

Lubrificare preventivamente l'interno del tubo presente sul motore, inserirvi quindi la barra (1) e sufficienti distanziali plastici (2) fino a centrare il cilindro con l'asse del motore. Bloccare quindi il cilindro stesso in questa posizione agendo sul dado (3) per recuperare eventuali giochi rimanenti. Assicurare la barra (1) al resto del cilindro mediante apposita rondella e dado autobloccante

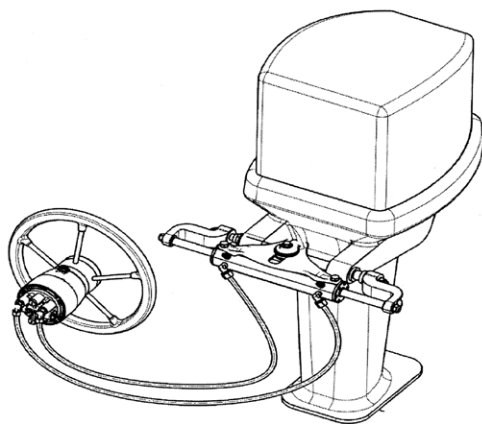

IMPORTANTE

Il cilindro AT12 è un cilindro a doppio effetto per timonerie a montaggio frontale. La pressione massima di esercizio è di 80 bar ed il massimo sforzo applicabile a questa pressione è 195 Kg, il volume massimo del cilindro è di 141 cc.

OUTBOARD BALANCED CYLINDER

*The outboard balanced cylinder **NOT** need to be fixed to the hull or support. Connect tubes as shown in figure. Connect tiller arm to bracket using nuts and bolts as included in application kit.*

Ensure that purge fittings are correctly upward.

Lubricate interior of engine tube, insert support rod (1) and sufficient plastic spacers (2) until cylinder is centered to engine center distance.

Block cylinder in position turning nut (3) until tight.

Connect support rod (1) to cylinder using washer and self-locking fastener as appropriate.

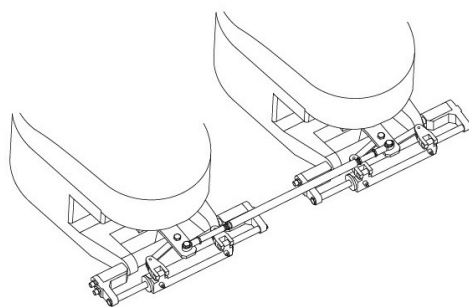

IMPORTANT

The cylinder AT12 is a cylinder to double effect for assemblage frontal steerings.

The maximum pressure of exercise is of 80 bar and the maximum applicable effort to this pressure is 195 Kg, the maximum volume of the cylinder is of 141 cc.

CILINDRI FUORIBORDO BILANCIATI DA DIPORTO

Lubrificare accuratamente la parte interna del tubo tilt sul motore con grasso marino anticorrosione e installare il cilindro fuoribordo in maniera analoga ai cavi tiro-spinta delle comuni timonerie meccaniche.

Avvitare sull'asta del cilindro l'apposita barra-prolunga (inclusa).

BALANCED OUTBOARD CYLINDER

Carefully lubricate interior of engine tilt tube with anticorrosion marine grease and install outboard cylinder as a mechanical push-pull steering cable.

Screw extension rod (included) onto cylinder rod.



SPONSOR - Ocean Rib Experience 2017





KIT FB115

Sistemi di guida per motorizzazioni con motore fuoribordo fino a 115 hp
Hydraulic steering package for outboard engine up to 115 hp



NEW

CARATTERISTICHE

Il sistema di guida KIT FB115 è consigliato indicativamente per imbarcazioni con motori fino a 115HP.
N° giri volante 6
Il volante non è incluso.

Cert. di esame CE in accordo con le direttive 2013/53/EU

FEATURES

KIT FB115 hydraulic steering system is suitable for boats with engine up to 115 HP.
Wheel turn 6
The wheel is not included

Exam Certification CE according to the directive 2013/53/EU

CODICI ORDINAZIONE / ORDER CODES

62.00883.00 Confezione KIT FB115 completo / *Complete package KIT FB115*

62.00883.01 Confezione KIT FB115 completo senza tubi / *Complete package KIT FB115 without hose*

LA CONFEZIONE KIT FB115 COMPRENDE / FB115 PACKAGE KIT CONTAINS:

62.00868.00

Cilindro fuoribordo
Outboard cylinder

62.00866.00

Pompa 19cc Semi-incasso 5 pistoni - P. max. 50 Bar
Pump 16cc - 5 piston - P. max 50 Bar

62.00604.00

RIVIERA HIDRAX 32 Olio idraulico 2 litri.
RIVIERA HIDRAX 32 Hydraulic Oil 2 lt

62.00603.70

TB7 Coppia tubi flessibili con raccordi preassemblati e 2 raccordi recuperabili. 5/16" - 7 mt (per lunghezze diverse specificare al momento dell'ordine).

B7 Hose kit with preassembled fittings and 2 connection recoverable. 5/16" - 7 mt (Specify length required when ordering).

**FINO A / UP TO
115HP**

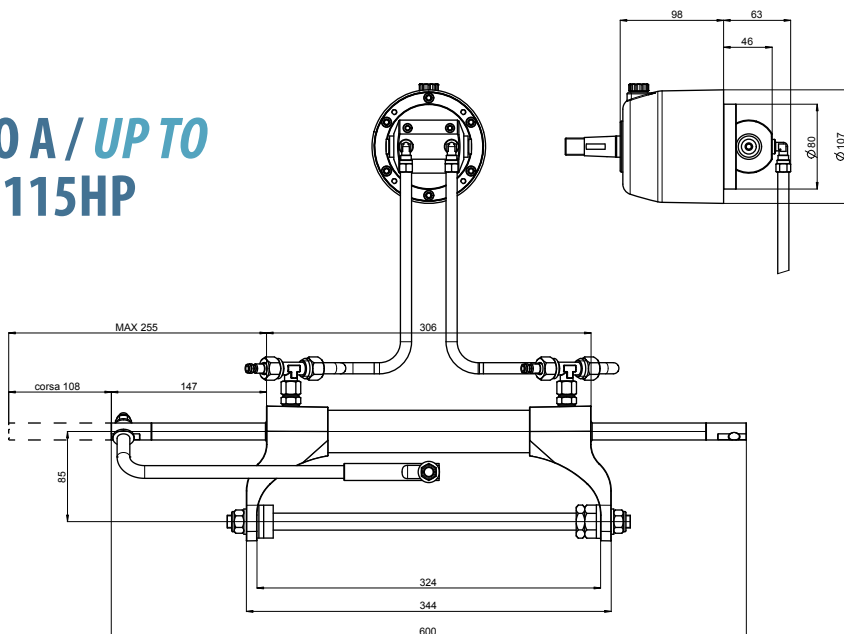

KIT FB175

Sistemi di guida per motorizzazioni con motore fuoribordo fino a 175 hp
Hydraulic steering package for outboard engine up to 175 hp



CARATTERISTICHE

Il sistema di guida KIT FB175 è consigliato indicativamente per imbarcazioni con motori fino a 175HP.
N° giri volante 6
Il volante non è incluso.

Cert. di esame CE in accordo con le direttive 2013/53/EU

FEATURES

KIT FB175 hydraulic steering system is suitable for boat with engine up to 175 HP.
Wheel turn 6
The wheel is not included

Exam Certification CE according to the directive 2013/53/EU

CODICI ORDINAZIONE / ORDER CODES

62.00884.00 Confezione KIT FB175 completo / *Complete package KIT FB175*

62.00884.01 Confezione KIT FB175 completo senza tubi / *Complete package KIT FB175 without hose*

LA CONFEZIONE KIT FB175 COMPRENDE / FB175 PACKAGE KIT CONTAINS:

62.00867.00

Cilindro fuoribordo
Outboard cylinder

62.00866.00

Pompa 19cc Semi-incasso - 5 pistoni - P. max. 50 Bar
Half-flush Pump 19cc - 5 piston - P. max 50 Bar

62.00604.00

RIVIERA HIDRAX 32 Olio idraulico 2 litri.
RIVIERA HIDRAX 32 Hydraulic Oil 2 lt

62.00603.70

TB7 Coppia tubi flessibili con raccordi preassemblati e 2 raccordi recuperabili.
5/16" - 7 mt (per lunghezze diverse specificare al momento dell'ordine).

B7 Hose kit with preassembled fittings and 2 connection recoverable. 5/16" - 7 mt (Specify length required when ordering).

**FINO A / UP TO
175HP**

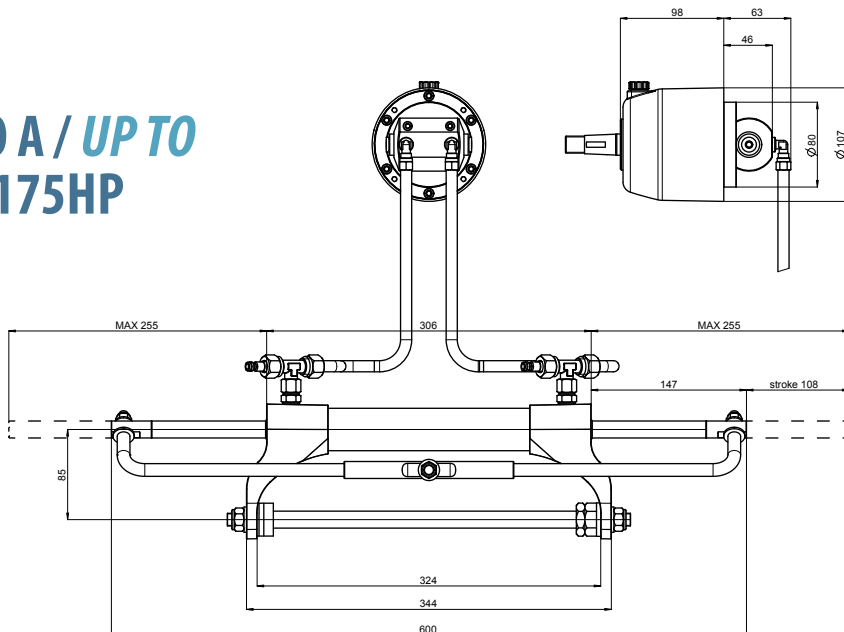



KIT FB250

Sistemi di guida per motorizzazioni con motore fuori bordo fino a 250 hp
Hydraulic steering package in kit for outboard engine up to 250 hp



CARATTERISTICHE

Il sistema di guida KIT FB250 è consigliato indicativamente per imbarcazioni con motori fino a 250HP.
N° giri volante 3,6
Il volante non è incluso.

Cert. di esame CE in accordo con le direttive 2013/53/EU

FEATURES

KIT FB250 hydraulic steering system is suitable for boat with engine up to 250 HP.
Wheel turn 3,6
The wheel is not included

Exam Certification CE according to the directive 2013/53/EU

CODICI ORDINAZIONE / ORDER CODES

62.00699.00 Confezione KIT FB250 completo / *Complete package KIT FB250*

62.00699.01 Confezione KIT FB250 completo senza tubi / *Complete package KIT FB250 without hose*

LA CONFEZIONE KIT FB250 COMPRENDE / FB250 PACKAGE KIT CONTAINS:

62.00593.00

AT12-101 Cilindro fuoribordo
AT12-101 Outboard cylinder

62.00600.00

Pompa 28cc - 7 pistoni - P. max. 70 Bar
Pump 28cc - 7 piston - P. max 70 Bar

62.00604.00

RIVIERA HIDRAX 32 Olio idraulico 2 litri.
RIVIERA HIDRAX 32 Hydraulic Oil 2 lt

62.00603.70

TB7 Coppia tubi flessibili con raccordi preassemblati e 2 raccordi recuperabili.
5/16" - 7 mt (per lunghezze diverse specificare al momento dell'ordine)
B7 Hose kit with preassembled fittings and 2 connection recoverable. **5/16"- 7 mt** (Specify length required when ordering).

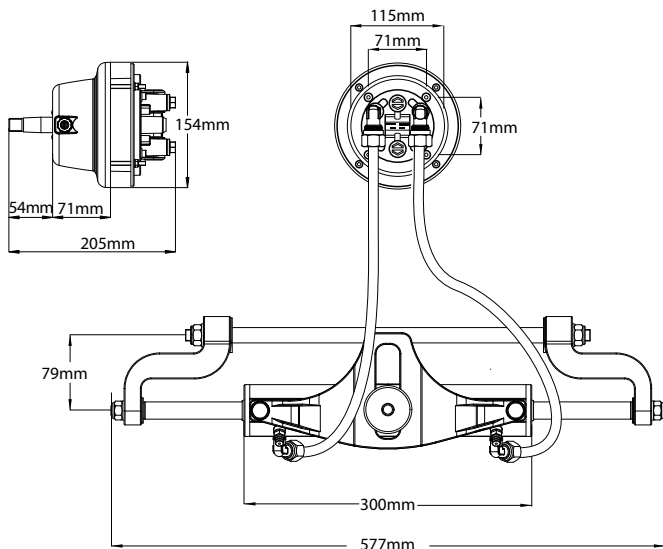

FINO A / UP TO 250HP

Accessori / Accessories



Accessorio per motore
Accessories for engine

HONDA 90/115/130/150 HP
MERCURY OPTIMAX 115/130 HP

COD. ORDINAZIONE
ORDER COD.
62.00756.00

KIT FB300

Sistemi di guida per motorizzazioni con motore fuoribordo fino a 300 hp
Hydraulic steering package for outboard engine up to 300 hp



CARATTERISTICHE

Il sistema di guida KIT FB350 è consigliato indicativamente per imbarcazioni con motori fino a 300HP.
N° giri volante 4,1
Il volante non è incluso.

Cert. di esame CE in accordo con le direttive 2013/53/EU

FEATURES

KIT FB350 hydraulic steering system is suitable for boat with engine up to 300 HP.
Wheel turn 4,1
The wheel is not included

Exam Certification CE according to the directive 2013/53/EU

CODICI ORDINAZIONE / ORDER CODES

62.00873.00 Confezione KIT FB300 completo / *Complete package KIT FB300*

62.00873.01 Confezione KIT FB300 completo senza tubi / *Complete package KIT FB300 without hose*

LA CONFEZIONE KIT FB300 COMPRENDE / FB300 PACKAGE KIT CONTAINS:

62.00583.00

AT12-141 Cilindro fuoribordo
AT12-141 Outboard cylinder

62.00601.00

Pompa 34cc - 7 pistoni - P. max. 70 Bar
Pump 34cc - 7 piston - P. max 70 Bar

62.00604.00

RIVIERA HIDRAX 32 Olio idraulico 2 litri.
RIVIERA HIDRAX 32 Hydraulic Oil 2 Lt

62.00603.70

TB7 Coppia tubi flessibili con raccordi preassemblati e 2 raccordi recuperabili.
5/16" - 7 mt (per lunghezze diverse specificare al momento dell'ordine).
B7 Hose kit with preassembled fittings and 2 connection recoverable. 5/16" - 7 mt (Specify length required when ordering).

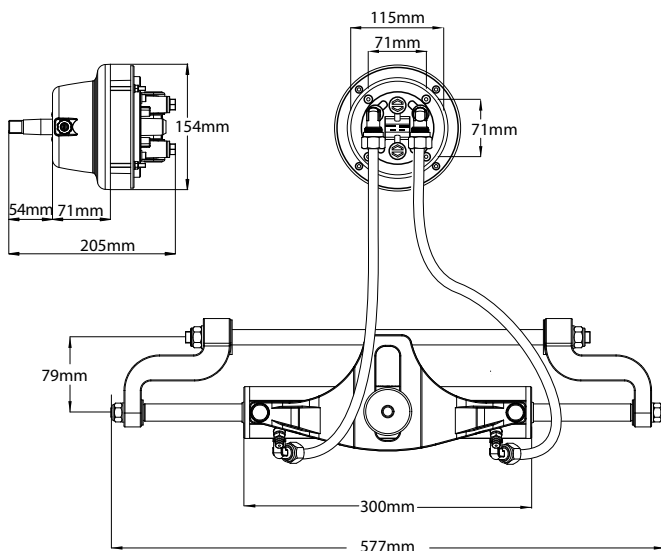

FINO A / UP TO 300HP

Accessori / Accessories



Accessorio per motore
Accessories for engine

HONDA 90/115/130/150 HP
MERCURY OPTIMAX 115/130 HP

COD. ORDINAZIONE
ORDER COD.
62.00756.00

HYDRAULIC STEERING SYSTEMS IN KIT - OUTBOARD



KIT FB350

Sistemi di guida per motorizzazioni con motore fuoribordo fino a 350 hp
Hydraulic steering package for outboard engine up to 350 hp



CARATTERISTICHE

Il sistema di guida KIT FB350 è consigliato indicativamente per imbarcazioni con motori fino a 350HP.
N° giri volante 3,6
Il volante non è incluso.

Cert. di esame CE in accordo con le direttive 2013/53/EU

FEATURES

KIT FB350 hydraulic steering system is suitable for boat with engine up to 350 HP.
Wheel turn 3,6
The wheel is not included

Exam Certification CE according to the directive 2013/53/EU

CODICI ORDINAZIONE / ORDER CODES

62.00700.00 Confezione KIT FB350 completo / *Complete package KIT FB350*

62.00700.01 Confezione KIT FB350 completo senza tubi / *Complete package KIT FB350 without hose*

LA CONFEZIONE KIT FB350 COMPRENDE / FB350 PACKAGE KIT CONTAINS:

62.00583.00

AT12-141 Cilindro fuoribordo
AT12-141 Outboard cylinder

62.00602.00

Pompa 39cc - 7 pistoni - P. max. 70 Bar
Pump 39cc - 7 piston - P. max 70 Bar

62.00604.00

RIVIERA HIDRAX 32 Olio idraulico 2 litri.
RIVIERA HIDRAX 32 Hydraulic Oil 2 lt

62.00603.70

TB7 Coppia tubi flessibili con raccordi preassemblati e 2 raccordi recuperabili.
5/16" - 7 mt (per lunghezze diverse specificare al momento dell'ordine).
B7 Hose kit with preassembled fittings and 2 connection recoverable. 5/16"- 7 mt (Specify length required when ordering).

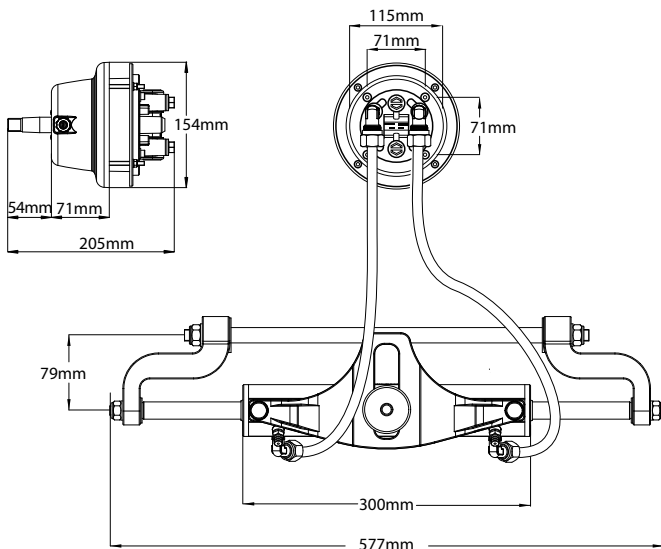

FINO A / UP TO 350HP

Accessori / Accessories



Accessorio per motore
Accessories for engine

HONDA 90/115/130/150 HP
MERCURY OPTIMAX 115/130 HP

COD. ORDINAZIONE
ORDER COD.
62.00756.00

CILINDRI ENTROBORDO DA DIPORTO BILANCIATI INBOARD BALANCED CYLINDER

INSTALLAZIONE DEI CILINDRI / CYLINDER INSTALLATION

Per garantire il buon funzionamento del cilindro, nonché la durata nel tempo di guarnizioni e altre parti usurabili, è necessario prestare molta attenzione in fase di montaggio.

Di seguito viene riportato uno schema che mostra il corretto metodo di installazione:

To ensure successful cylinder operation and longer durability of seals and over parts subject to wear, it is necessary to use special care in installation.

Correct installation is illustrated in the diagram as follows below:

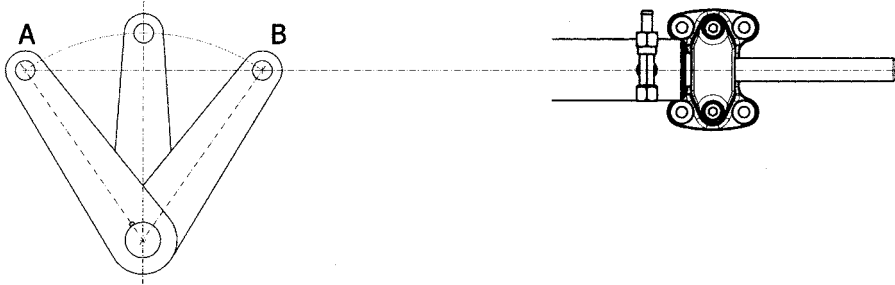

Le lettere A e B rappresentano i punti di fine corsa della barra del timone.

Allineare l'ipotetica retta passante per i punti A e B.

Letters A and B represent tiller arm hard-over positions. Align AB line to cylinder centerline.

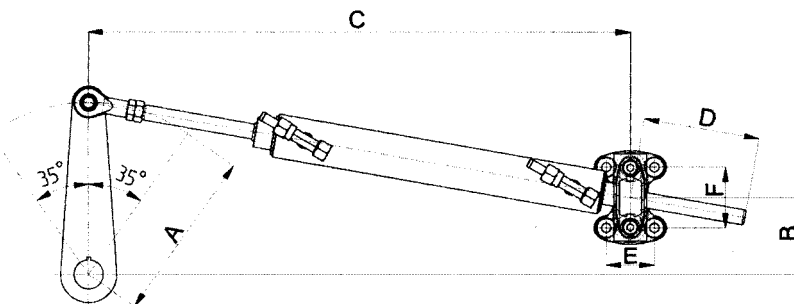

Le quote indicate con le lettere C e D sono calcolate ipotizzando lo snodo sferico in posizione centrale rispetto alla propria zona di regolazione: è possibile pertanto registrarne la posizione (fino a 3 mm per parte) per correggere eventuali errori di disallineamento.

C and D dimensions are calculated based on central ball joint relative to its regulation zone.

Ball joint position can be adjusted up to 3 mm per side to correct any alignment errors.

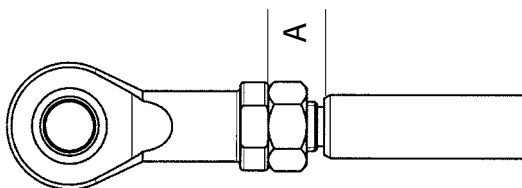

La quota "A" non deve mai essere maggiore a 18 mm

Dimension 'A' must never be in excess of 18 mm



IMPORTANTE / IMPORTANTN

- Il montaggio del pistone sull'imbarcazione deve essere effettuato, se possibile, mediante utilizzo di bulloni passanti da preferire alle viti autofilettanti.
Mounting cylinder onto craft must preferably be by through bolts than lag screws.
- I raccordi per le tubazioni devono essere posti in posizione alta: qualora la natura dell'installazione lo rendesse impossibile, il cilindro deve essere fissato in posizione solo DOPO aver eseguito tutte le procedure di riempimento e spurgo del sistema di seguito riportate.
Tube fittings must be in upward position. If not possible, the cylinder should be installed only after filling and purging of the steering systems has been performed as follow below.
- Proteggere in maniera adeguata lo stelo del cilindro da urti accidentali che potrebbero inficiarne il corretto funzionamento.
Adequately protect cylinder rod from accidental collision that may cause steering malfunction.
- In caso di eventuale corrosione di uno o più particolari (possibile se il cilindro viene impiegato in ambienti particolarmente corrosivi), intervenire per tempo sostituendo le parti intaccate.
Corrosion may occur if cylinder utilization is in highly

INSTALLAZIONE / INSTALLATION

- Allineare il timone all'asse prua-poppa.
Align rudder to boat centerline.
- Allentare i raccordi per le tubazioni
Loosen tube fittings.
- Posizionare il cilindro sull'imbarcazione facendo riferimento alle dimensioni "B", "C" e "D" dello schema sopra riportato.
Posizionare locate cylinder onto craft based on dimensions B, C and D as configured above.
- Assicurare il montaggio della staffa sul cilindro con 4 bulloni passanti e altrettanti dadi autofrenanti. (non inclusi) ; utilizzare solo viteria in acciaio inox.
Ensure support bracket is mounted onto cylinder by 4 through srews and 4 self locking nuts (not included); only utilize stainless steel nuts and screws.
- Verificare la libertà di movimento del pistone ruotando completamente il timone. Nelle posizioni di fine corsa l'asse del pistone dovrà trovarsi orizzontale.
Check piston movement by turning helm to hard- over in both directions. Piston centerline must be horizontal at both hard-over positions.



SPONSOR - Nordkapp Rib Mission 2012

KIT EB50

Sistemi di guida per motorizzazioni con motore entrobordo fino a 10 mt
Hydraulic steering package in kit for inboard engine up to 10 mt



CARATTERISTICHE

Il sistema di guida KIT EB50 è consigliato indicativamente per imbarcazioni con motori fino a 50HP. N° giri volante 5,0
Il volante non è incluso.

Cert. di esame CE in accordo con le direttive 2013/53/EU

FEATURES

KIT EB50 hydraulic steering system is suitable for boat with engine up to 50 HP.
Wheel turn 5,0
The wheel is not included

Exam Certification CE according to the directive 2013/53/EU

CODICI ORDINAZIONE / ORDER CODES

62.00852.00 Confezione KIT EB50 completo / *Complete package KIT EB50*

62.00852.01 Confezione KIT EB50 completo senza tubi / *Complete package KIT EB50 without hose*

LA CONFEZIONE KIT EB50 COMPRENDE / EB50 PACKAGE KIT CONTAINS:

62.00591.00

Cilindro entrobordo
Inboard cylinder

62.00866.00

Pompa 19cc Semi-incasso - 5 pistoni - P. max. 50 Bar
Pump 19cc - 5 piston - P. max 50 Bar

62.00604.00

RIVIERA HIDRAX 32 Olio idraulico 2 litri.
RIVIERA HIDRAX 32 Hydraulic Oil 2 Lt

62.00603.70

TB7 Coppia tubi flessibili con raccordi preassemblati e 2 raccordi recuperabili.
5/16" - 7 mt (per lunghezze diverse specificare al momento dell'ordine).
B7 Hose kit with preassembled fittings and 2 connection recoverable. 5/16" - 7 mt (Specify length required when ordering).

**FINO A / UP TO
10mt.**

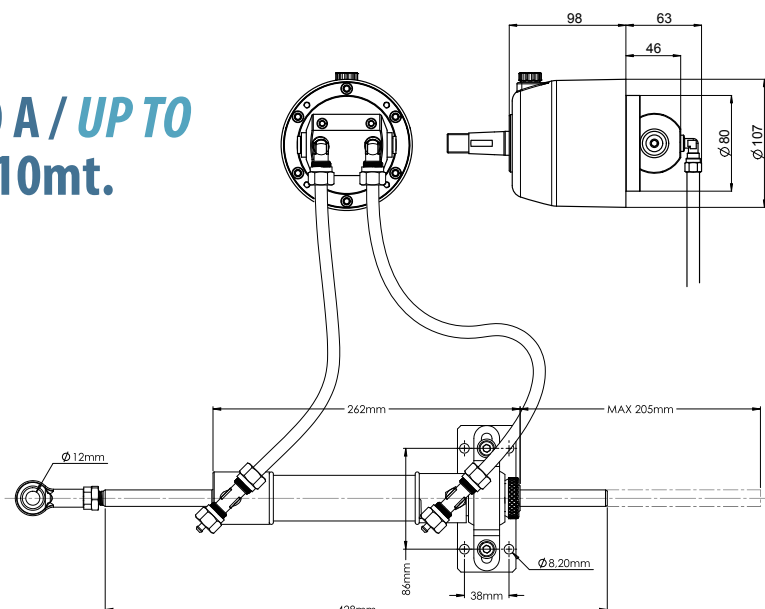



KIT EB75

Systemi di guida per motorizzazioni con motore entrobordo fino a 12 mt
Hydraulic steering package in kit for inboard engine up to 12 mt



CARATTERISTICHE
Il sistema di guida KIT EB75 è consigliato indicativamente per imbarcazioni con motori fino a 75HP. N° giri volante 5,0
Il volante non è incluso.

Cert. di esame CE in accordo con le direttive 2013/53/EU

FEATURES
KIT EB75 hydraulic steering system is suitable for boat with engine up to 75 HP.
Wheel turn 5,0
The wheel is not included

Exam Certification CE according to the directive 2013/53/EU

CODICI ORDINAZIONE / ORDER CODES

- 62.00853.00** Confezione KIT EB75 completo / *Complete package KIT EB75*
- 62.00853.01** Confezione KIT EB75 completo senza tubi / *Complete package KIT EB75 without hose*

LA CONFEZIONE KIT EB75 COMPRENDE / EB75 PACKAGE KIT CONTAINS:

- 62.00584.00**
AT12-101 Cilindro entrobordo
AT12-101 Inboard cylinder
- 62.00600.00**
Pompa 28cc - 7 pistoni - P. max. 70 Bar
Pump 28cc - 7 piston - P. max 70 Bar
- 62.00604.00**
RIVIERA HIDRAX 32 Olio idraulico 2 litri.
RIVIERA HIDRAX 32 Hydraulic Oil 2 lt

- 62.00603.70**
TB7 Coppia tubi flessibili con raccordi preassemblati e 2 raccordi recuperabili.
5/16" - 7 mt (per lunghezze diverse specificare al momento dell'ordine).
B7 Hose kit with preassembled fittings and 2 connection recoverable. 5/16"- 7 mt (Specify length required when ordering).

48 HYDRAULIC STEERING SYSTEMS IN KIT - INBOARD

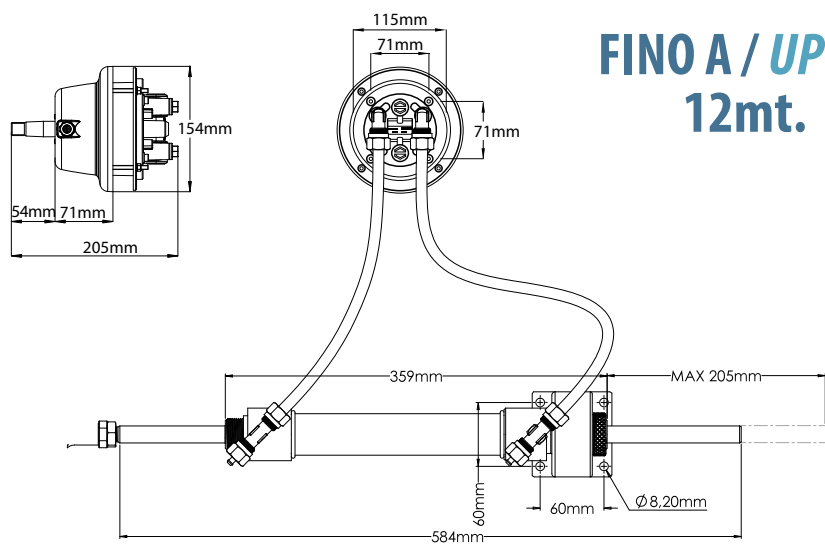

FINO A / UP TO 12mt.

SERIE HEAVY - Pompa a montaggio frontale imbarcazioni da lavoro
Front mounting pump for fishing and merchants vessels

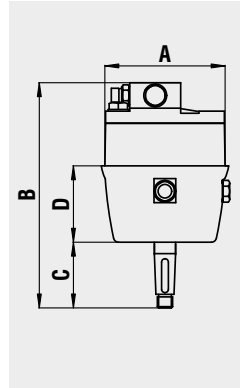

CODICI ORDINAZIONE / ORDER CODES

	Portata cc/giro <i>Displacement</i>	Pistoni <i>Pistons</i>	Diam. volante <i>Wheel diam.</i>	Peso Kg <i>Weight Kg</i>	P. max Bar <i>P. max Bar</i>	A <i>A</i>	B <i>B</i>	C <i>C</i>	D <i>D</i>
62.00693.00	45	7	500	4,5	100	127	211	38	80
62.00694.00	56	7	600	7,5	100	142	265	77	90
62.00695.00	68	7	700	7,5	100	142	265	77	90
62.00696.00	80	7	800	15	100	172	314	77	121
62.00697.00	100	7	900	15	100	172	314	77	121

SERIE HEAVY - Pompa a montaggio retrocruscotto imbarcazioni da lavoro
Rear mounting pump for fishing and merchants vessels

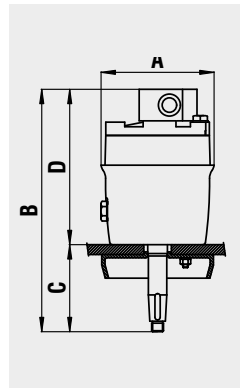

CODICI ORDINAZIONE / ORDER CODES

	Portata cc/giro <i>Displacement</i>	Pistoni <i>Pistons</i>	Diam. volante <i>Wheel diam.</i>	Peso Kg <i>Weight Kg</i>	P. max Bar <i>P. max Bar</i>	A <i>A</i>	B <i>B</i>	C <i>C</i>	D <i>D</i>
62.00701.00	45	7	500	4,5	100	127	254	89	165
62.00669.00	56	7	600	7,5	100	142	315	128	187
62.00670.00	68	7	700	7,5	100	142	315	128	187
62.00671.00	80	7	800	15	100	172	369	132	237
62.00672.00	100	7	900	15	100	172	369	132	237

ATIL5 Cilindri entro bordo bilanciati per imbarcazioni da lavoro
Inboard balanced cylinder for fishing and merchants vessels

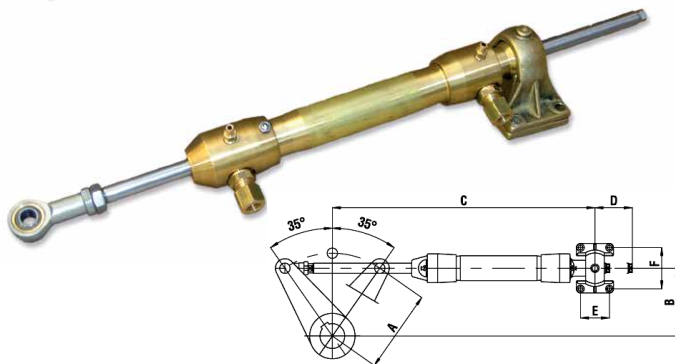

- CARATTERISTICHE**
- Bilanciato: uguale numero di giri da mezza-corsa a fine-corsa
 - Raccordi da 1/4
 - Camicia in ottone
 - Stelo in acciaio cromato

- FEATURES**
- *Balanced: the number of turns lock-to-lock is equal port to starboard or viceversa.*
 - *Fittings 1/4*
 - *Alluminium anodized liner*
 - *Chromium*

CARATTERISTICHE / KEY FEATURES

Camicia / <i>Liner</i> :	Ottone / <i>Brass</i>
Stelo / <i>Stem</i> :	Acciaio cromato / <i>Chromium plated steel</i>
Raccordi / <i>Fittings</i> :	1/4 / 1/4

CODICI ORDINAZIONE / ORDER CODES

	Diam. mm <i>Diam. mm</i>	Corsa mm <i>Stroke mm.</i>	Spinta Kg <i>Output Kg</i>	Stelo mm <i>Shank mm</i>	Vol. cc <i>Vol. cc</i>	MT kgm <i>MT kgm</i>	A mm <i>A mm</i>	B mm <i>B mm</i>	C mm <i>C mm</i>	D mm <i>D mm</i>	E mm <i>E mm</i>	F mm <i>F mm</i>
62.00677.00	50	300	1473*	25	442	281	260	212	765	311	70	70
62.00679.00	60	250	2195*	30	530	340	218	178	722	263	120	104
62.00680.00	65	300	2611*	30	783	502	260	214	798	283	120	104
62.00702.00	40	160	1472*	25	236	151	139	114	429	107	70	90

*@ 70 bar

ATIL6 Cilindri entro bordo bilanciati per imbarcazioni da lavoro
Inboard balanced cylinder for fishing and merchants vessels

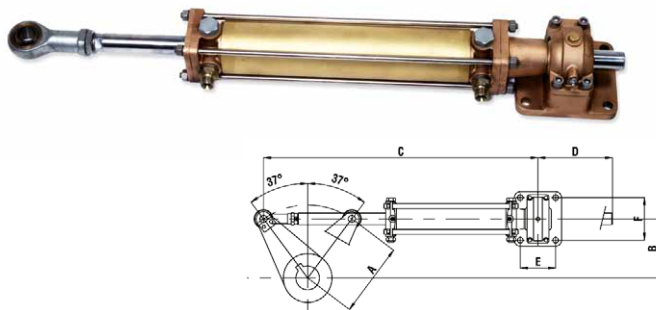

- CARATTERISTICHE**
- Bilanciato: uguale numero di giri da mezza-corsa a fine-corsa
 - Raccordi da 1/2
 - Camicia in ottone
 - Stelo in acciaio cromato

- FEATURES**
- *Balanced: the number of turns lock-to-lock is equal port to starboard or viceversa.*
 - *Fittings 1/2*
 - *Alluminium anodized liner*
 - *Chromium*

CARATTERISTICHE / KEY FEATURES

Camicia / <i>Liner</i> :	Ottone / <i>Brass</i>
Stelo / <i>Stem</i> :	Acciaio cromato / <i>Chromium plated steel</i>
Raccordi / <i>Fittings</i> :	1/2 / 1/2

CODICI ORDINAZIONE / ORDER CODES

	Diam. mm <i>Diam. mm</i>	Corsa mm <i>Stroke mm.</i>	Spinta Kg <i>Output Kg</i>	Stelo mm <i>Shank mm</i>	Vol. cc <i>Vol. cc</i>	MT kgm <i>MT kgm</i>	A mm <i>A mm</i>	B mm <i>B mm</i>	C mm <i>C mm</i>	D mm <i>D mm</i>	E mm <i>E mm</i>	F mm <i>F mm</i>
62.00683.00	80	300	3678*	40	1130	662	250	200	782	190	120	145
62.00684.00	90	300	5102*	40	1530	918	250	200	782	190	120	145

*@ 70 bar

ATIL7 Cilindri entrobordo bilanciati per imbarcazioni da lavoro Inboard balanced cylinder for fishing and merchants vessels

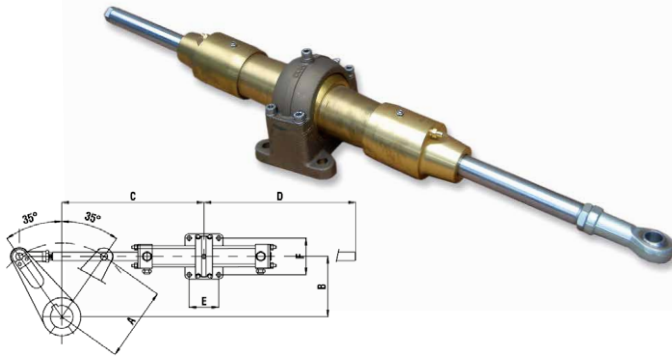

CARATTERISTICHE

- Bilanciato: uguale numero di giri da mezza-corsa a fine-corsa
- Raccordi da 3/8 (689/690) 1/2 (691/692)
- Camicia in ottone
- Stelo in acciaio cromato

FEATURES

- *Balanced: the number of turns lock-to-lock is equal port to starboard or viceversa.*
- *Fittings 3/8 (685/686) 1/2 (687/688)*
- *Alluminium anodized liner*
- *Chromium plated*

CARATTERISTICHE / KEY FEATURES

Camicia / <i>Liner</i> :	Ottone / <i>Brass</i>
Stelo / <i>Stem</i> :	Acciaio cromato / <i>Chromium plated steel</i>
Raccordi / <i>Fittings</i> :	3/8 (689/690) 1/2 (691/692) / 3/8 (689/690) 1/2 (691/692)

CODICI ORDINAZIONE / ORDER CODES

	Diam. mm <i>Diam. mm</i>	Corsa mm <i>Stroke mm.</i>	Spinta Kg <i>Output Kg</i>	Stelo mm <i>Shank mm</i>	Vol. cc <i>Vol. cc</i>	MT kgm <i>MT kgm</i>	A mm <i>A mm</i>	B mm <i>B mm</i>	C mm <i>C mm</i>	D mm <i>D mm</i>	E mm <i>E mm</i>	F mm <i>F mm</i>
62.00689.00	50	230	1473*	25	339	217	200	164	412	498	80	100
62.00690.00	50	300	1473*	25	442	281	260	212	506	610	80	100
62.00691.00	60	250	2119*	30	530	340	218	178	454	506	105	130
62.00692.00	65	300	2611*	30	783	502	260	212	504	553	105	130

*@ 70 bar

ATIL8 Cilindri asserviti bilanciati per imbarcazioni da lavoro Inboard servo assisted cylinder for fishing and merchants vessel



CARATTERISTICHE

- Bilanciato: uguale numero di giri da mezza-corsa a fine-corsa
- Raccordi da 3/8 (685/686) 1/2 (687/688)
- Camicia in ottone
- Stelo in acciaio cromato

FEATURES

- *Balanced: the number of turns lock-to-lock is equal port to starboard or viceversa.*
- *Fittings 3/8 (685/686) 1/2 (687/688)*
- *Alluminium anodized liner*
- *Chromium plated*

CARATTERISTICHE / KEY FEATURES

Camicia / <i>Liner</i> :	Ottone / <i>Brass</i>
Stelo / <i>Stem</i> :	Acciaio cromato / <i>Chromium plated steel</i>
Raccordi / <i>Fittings</i> :	3/8 (685/686) 1/2 (687/688) / 3/8 (685/686) 1/2 (687/688)

CODICI ORDINAZIONE / ORDER CODES

	Diam. mm <i>Diam. mm</i>	Corsa mm <i>Stroke mm.</i>	Spinta Kg <i>Output Kg</i>	Stelo mm <i>Shank mm</i>	Vol. cc <i>Vol. cc</i>	MT kgm <i>MT kgm</i>	A mm <i>A mm</i>	B mm <i>B mm</i>	C mm <i>C mm</i>	D mm <i>D mm</i>	E mm <i>E mm</i>	F mm <i>F mm</i>
62.00685.00	---	250	-----	---	339	152	200	156	667	380	70	100
62.00686.00	---	300	-----	---	445	197	260	212	765	380	70	100
62.00687.00	---	250	-----	---	530	238	218	178	722	336	120	104
62.00688.00	---	300	-----	---	783	351	260	212	798	386	120	104



COLLEGAMENTO A CILINDRI

I cilindri idraulici RIVIERA sono predisposti con raccorderia a passo 1/4" NPT. Utilizzare tubo flessibile o in rame di diametro esterno 10 mm o tubo terminato con specifici raccordi.

COLLEGAMENTO TUBAZIONI SENZA TERMINALE

Svitare il dado del raccordo presente sul cilindro e rimuovere il cappuccio di protezione. Inserire il dado sul tubo e il tubo all'interno del raccordo portandolo a battuta. Assicurare il montaggio avvitando il dado con apposita chiave (non fornita).

COLLEGAMENTO TUBAZIONI CON TERMINALE

Svitare il dado del raccordo presente sul cilindro e rimuovere il cappuccio di protezione. Rimuovere il cappuccio di protezione del terminale sul tubo. Inserire il dado nel terminale e il terminale all'interno del raccordo fino a battuta. Assicurare il montaggio avvitando il dado con l'apposita chiave (non fornita).

COLLEGAMENTO TIMONERIA

Rimuovere i tappi color giallo indicati con la lettera **A** nella figura per collegare la timoneria al pistone idraulico.

Rimuovere i tappi color nero indicati con la lettera **B** nella figura **1 SOLO** per collegare la timoneria ad eventuali stazioni supplementari.

Utilizzare mastice tipo Loctite 542 o equivalenti per assicurare il serraggio dei raccordi.

ATTENZIONE:

La tenuta dei raccordi deve essere assicurata unicamente mediante l'impegno di materiali liquidi quali Loctite o simili. L'impiego di nastro isolante o teflon potrebbe pregiudicare il corretto funzionamento della timoneria o danneggiarla in modo permanente. Evitare, inoltre, l'immissione nel circuito del materiale liquido di tenuta piegato.

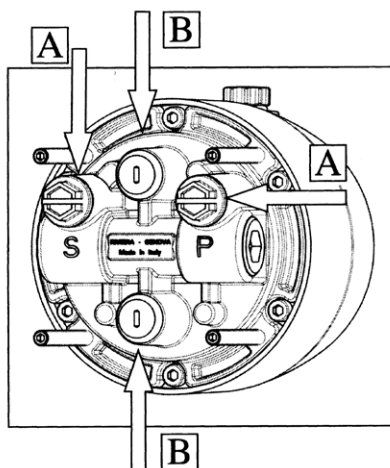

CAUTION:

ONLY utilize liquid sealants Loctite or equivalent to secure tightened fittings. Do not use tape or teflon sealers that may cause steering malfunction or permanently damaged steering. Also prevent liquid sealant contaminating the system

CONNECTING HOSE TO CYLINDERS

Riviera hydraulic cylinders are supplied with 1/4" NPT fittings. Utilize flexible hose or copper hose with 10 mm outer diameter or specific preinstalled end fittings hose.

CONNECTING HOSE TO CYLINDER (NO PREASSEMBLED HOSE END FITTINGS)

Unscrew bolted fitting on cylinder and remove protective cap. Slide nut over hose and insert hose into fitting to bottom. Thread nut tight using wrench (not included).

CONNECTING HOSE TO CYLINDER (PREASSEMBLED HOSE END FITTINGS)

Unscrew bolted fitting on cylinder and remove protective cap. Remove protective cap from hose fitting. Slide nut over hose end fitting and hose end fitting into cylinder fitting to bottom. Thread nut tight using wrench (not included).

CONNECTING HOSE TO STEERING HELM

Remove letter **A** yellow caps in side figure to connect steering helm to hydraulic piston..

ONLY remove letter **B** black caps in figure to connect steering helm station to second helm station. Utilize sealant Loctite 542 or equivalent to secure tightened fittings.

SISTEMA DI GUIDA A STAZIONE SINGOLA



COLLEGAMENTO AD ATTUATORE CON STELO FISSO

Collegare la bottiglia dell'olio e riempire completamente il serbatoio della timoneria (olio visibile nel tubo trasparente), verificare l'assenza di bolle d'aria.

Il tubo trasparente dovrà rimanere pieno per tutta la durata dell'operazione, nel caso in cui il contenuto della bottiglia non fosse sufficiente sostituirla con una nuova.

Per il collegamento ad attuatore con stelo fisso, aprire la valvola di spurgo sul pistone (**vedi schema 1 - fig 2**) e ruotare il volante come illustrato fino alla

completa eliminazione dell'aria: dalla valvola dovrà fuoriuscire SOLO olio.

Chiudere la valvola e continuare a ruotare il volante nella STESSA direzione fino al raggiungimento del fondo corsa.

Aprire la seconda valvola di spurgo e ruotare in direzione contraria alla precedente il volante fino alla totale fuoriuscita dell'aria dalla valvola.

Chiudere la valvola e continuare a ruotare il volante nella stessa direzione fino al raggiungimento del fondo corsa.

Ripetere le operazioni precedenti fino alla totale eliminazione dell'aria residua dal circuito.

ATTENZIONE:

La rotazione del volante durante le operazioni di riempimento va eseguita LENTAMENTE; l'eccessiva rapidità nella manovra dello stesso potrebbe formare schiuma all'interno del circuito. In questo caso si raccomanda di attendere almeno 24 ore prima di procedere con le operazioni successive.

SCHEMA 1

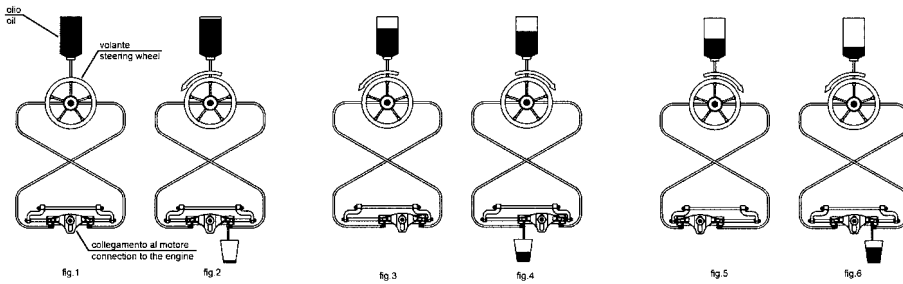

SISTEMA DI GUIDA A STAZIONE SINGOLA

COLLEGAMENTO AD ATTUATORE CON STELO MOBILE

Per il collegamento ad attuatore con stelo mobile, (**vedi schema 2**) seguire le operazioni descritte per il riempimento per il "collegamento a pistone con stelo fisso" facendo riferimento allo schema corretto.

ATTENZIONE:

dopo ogni installazione eseguire un check del sistema ruotando il volante diverse volte fino al raggiungimento del fondo corsa prima in un senso e poi nell'altro.

SCHEMA 2

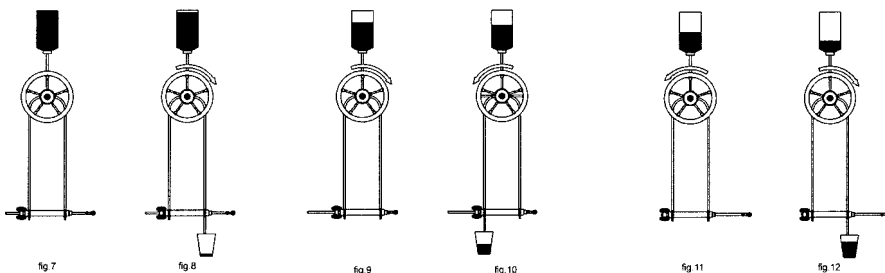



SINGLE STEERING STATION SYSTEM

CONNECTION TO FIXED CYLINDER ROD

Connect the oil bottle and fill the tank of the helm (oil visible in the transparent tube), verify the absence of air bubbles.

The tube transparent must remain fully for the duration of the operation, when the contents of the bottle was not enough to replace it with a new one.

For connection to fixed cylinder rod open right bleeder on cylinder body (**diagram 1 - fig 2**) and turn steering

wheel as illustrated until air is completely eliminated: oil ONLY should come out of the bleeder.

Close bleeder and continue SAME steering wheel rotation until steering wheel comes to halt.

Open the other bleeder and turn steering wheel in opposite direction until air is completely eliminated. Close bleeder and continue same steering wheel rotation until steering wheel comes to halt. Reiterate procedure until complete air elimination.

CAUTION:

Steering wheel rotation during filling procedures must be SLOW. In the event that excess fastness may cause air bubbles in oil, we recommend you to wait no less than 24 hours before continuing to next steps

DIAGRAM 1

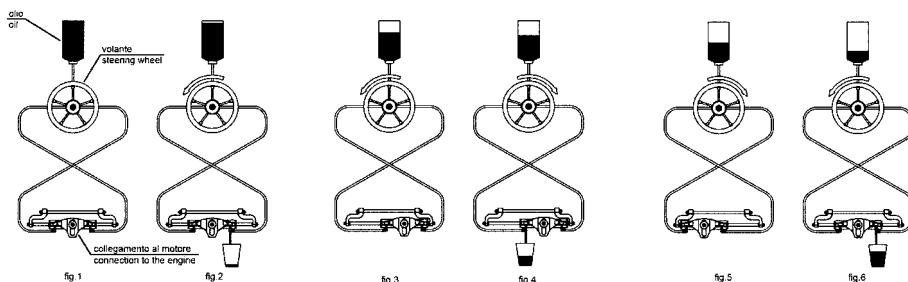

SINGLE STEERING STATION SYSTEM

CONNECTION TO MOBILE CYLINDER ROD

For connection to mobile cylinder rod (diagram 2) follow the steps for filling the "connecting piston rod fixed" by referring to the correct schema.

CAUTION:

Check proper steering system installation after each procedure. Turn steering wheel until fully stroked in both directions.

DIAGRAM 2

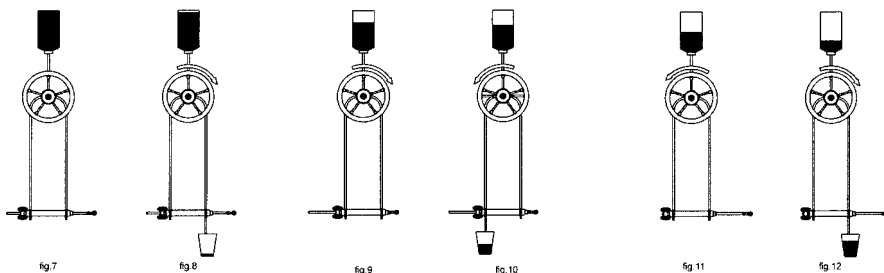

SISTEMA DI GUIDA A STAZIONE MULTIPLA



COLLEGAMENTO AD ATTUATORE CON STELO FISSO

STAZIONE SINGOLA → PIU' CILINDRI:

Eseguire il collegamento come mostrato in **schema 3 fig.13**

Procedere come descritto in precedenza (schema 3) agendo passo per passo, prima su un cilindro e successivamente sull'altro fino al completo riempimento del circuito.

STAZIONI MULTIPLE → PIU' CILINDRI:

Eseguire il collegamento come mostrato in **schema 3 fig.15**

Procedere come descritto in precedenza (schema 3) agendo passo per passo, prima su un cilindro e successivamente sull'altro, ruotare prima il timone posto più in basso e in seguito quello posto più in alto fino al completo riempimento del circuito.

STAZIONI MULTIPLE → UN CILINDRO:

Eseguire il collegamento come mostrato in **schema 3 fig.17**

Procedere come descritto in precedenza (schema 3) ruotando prima il timone posto più in basso e in seguito quello posto più in alto fino al completo riempimento del circuito.

SCHEMA 3

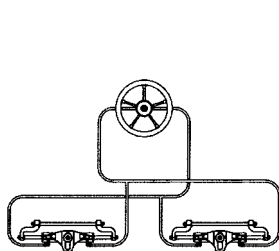

Fig. 13

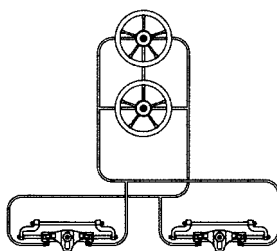

Fig. 15

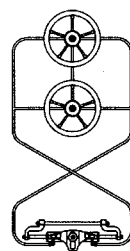

Fig. 17

SISTEMA DI GUIDA A STAZIONE MULTIPLA

COLLEGAMENTO AD ATTUATORE CON STELO MOBILE

STAZIONE SINGOLA → PIU' CILINDRI:

Eseguire il collegamento come mostrato in **schema 4 fig.14**

Procedere come descritto in precedenza (schema 4) agendo passo per passo, prima su un cilindro e successivamente sull'altro fino al completo riempimento del circuito.

STAZIONI MULTIPLE → PIU' CILINDRI:

Eseguire il collegamento come mostrato in **schema 4 fig.16**

Procedere come descritto in precedenza (schema 4) agendo passo per passo, prima su un cilindro e successivamente sull'altro, ruotare prima il timone posto più in basso e in seguito quello posto più in alto fino al completo riempimento del circuito.

STAZIONI MULTIPLE → UN CILINDRO:

Eseguire il collegamento come mostrato in **schema 4 fig.18**

Procedere come descritto in precedenza (schema 4) ruotando prima il timone posto più in basso e in seguito quello posto più in alto fino al completo riempimento del circuito.

SCHEMA 4

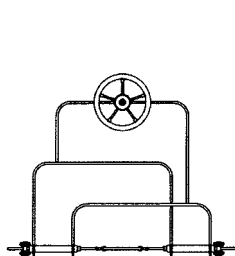

Fig. 14

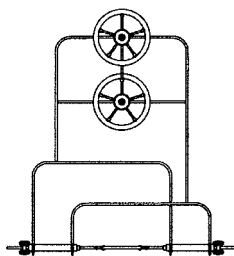

Fig. 16

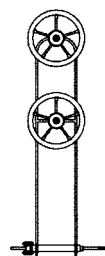

Fig. 18



MULTIPLE STEERING STATION SYSTEM

CONNECTION TO FIXED CYLINDER ROD

SINGLE STATION → MULTIPLE CYLINDERS:

Perform installation as shown in **diagram 3 fig.13**

Perform steps as in diagram 3, on one cylinder first and then on the other, until system is full.

MULTIPLE STATIONS → MULTIPLE CYLINDERS:

Perform connection as shown in **diagram 3 fig.15**

Perform steps as in diagram 3, on one cylinder first and then on the other. Turn steering wheel at helms other than upper station first. Last turn steering wheel at upper helm station, until system is full.

MULTIPLE STATIONS → ONE CYLINDER:

Perform connection as shown in **diagram 3 fig.17**

Perform steps as in diagram 3. Turn steering wheel at helms other than upper station first. Last turn steering wheel at upper helm station, until system is full.

DIAGRAM 3

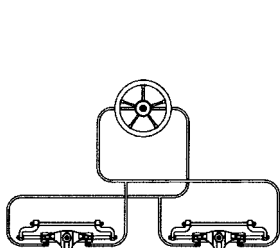

Fig. 13

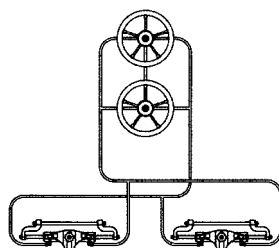

Fig. 15

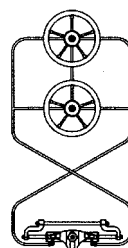

Fig. 17

MULTIPLE STEERING STATION SYSTEM

CONNECTION TO MOBILE CYLINDER ROD

SINGLE STATION → MULTIPLE CYLINDERS:

Perform installation as shown in **diagram 4 fig.14**

Perform steps as in diagram 3, on one cylinder first and then on the other, until system is full..

MULTIPLE STATIONS → MULTIPLE CYLINDERS:

Perform connection as shown in **diagram 4 fig.16**

Perform steps as in diagram 3, on one cylinder first and then on the other. Turn steering wheel at helms other than upper station first. Last turn steering wheel at upper helm station, until system is full.

MULTIPLE STATIONS → ONE CYLINDER:

Perform connection as shown in **diagram 4 fig.18**

Perform steps as in diagram 3. Turn steering wheel at helms other than upper station first. Last turn steering wheel at upper helm station, until system is full.

DIAGRAM 4

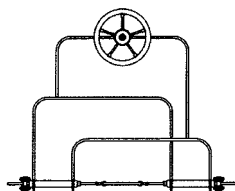

Fig. 14

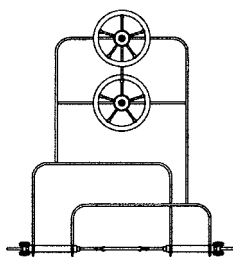

Fig. 16

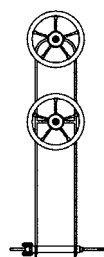

Fig. 18

OLIO / HYDRAULIC FLUID



CARATTERISTICHE / KEY FEATURES

Le timonerie **Riviera** utilizzano **HYDRAX 32** in conformità con **DIN 51524-2**

Riviera steering systems utilize HYDRAX 32 in conformity with Din 51524-2

- Densità relativa / *Relative density*: 0.868 gr/cc a 15°C

- Viscosità / *Viscosity*: 32 CST a 40°C

POMPE / PUMPS

CODICI ORDINAZIONE / ORDER CODES

	Portata <i>Displac.</i>	n° Pistoni <i>n° Pistons</i>	Peso (Kg) <i>Weight (Kg)</i>	Pressione max <i>Pressure max</i>	Applicazione <i>Mounting position</i>
62.00866.00	19 cc	5	2,7	50 BAR	Semi incasso / <i>Half flush mount</i>
62.00600.00	28 cc	7	5	70 BAR	Semi incasso / <i>Half flush mount</i>
62.00601.00	34 cc	7	5	70 BAR	Semi incasso / <i>Half flush mount</i>
62.00602.00	39 cc	7	5	70 BAR	Semi incasso / <i>Half flush mount</i>
Per imbarcazioni da lavoro / <i>For fishing and merchants vessel</i>					
62.00693.00	45 cc	7	4,5	100 BAR	Frontale / <i>Front mount</i>
62.00694.00	56 cc		7,5		Frontale / <i>Front mount</i>
62.00695.00	68 cc		7,8		Frontale / <i>Front mount</i>
62.00696.00	80 cc		15		Frontale / <i>Front mount</i>
62.00697.00	100 cc		15		Frontale / <i>Front mount</i>
62.00701.00	45 cc	7	4,5	100 BAR	Retro cruscotto / <i>Rear mount</i>
62.00669.00	56 cc		7,5		Retro cruscotto / <i>Rear mount</i>
62.00670.00	68 cc		7,8		Retro cruscotto / <i>Rear mount</i>
62.00671.00	80 cc		15		Retro cruscotto / <i>Rear mount</i>
62.00672.00	100 cc		15		Retro cruscotto / <i>Rear mount</i>

Raccorderia utilizzata 1/4" NPT; impiegare come sigillante Loctite 542 o Loctite 545.

Fittings are 1/4" NPT; use sealants Loctite 542 or Loctite 545.

PISTONI / CYLINDERS

CODICI ORDINAZIONE / ORDER CODES

	Portata <i>Displac.</i>	Ø Pistone <i>Piston. Ø</i>	Ø Stelo <i>Rod. Ø</i>	P. Max <i>P. Max</i>	Spinta <i>Output force</i>	Corsa <i>Stroke</i>	Applicazione <i>Application</i>
62.00868.00	120cc	32mm	16mm	725 Psi – 50Bar	250Kg	200mm	115HP Fuoribordo/ <i>Outboard</i>
62.00867.00	120cc	32mm	16mm	725 Psi – 50Bar	250Kg	200mm	175HP Fuoribordo/ <i>Outboard</i>
62.00593.00	100cc	30mm*	16mm		354Kg	200mm	250HP Fuoribordo/ <i>Outboard</i>
62.00583.00	141cc	35mm*	18mm		495Kg	200mm	350HP Fuoribordo/ <i>Outboard</i>
62.00591.00	57cc	25mm	12mm		264kg	150mm	Entrobordo / <i>Inboard</i>
62.00584.00	116cc	32mm	14mm		455kg	178mm	
62.00677.00	442cc	50mm	25mm		1473kg	300mm	Entrobordo per imbarcazioni da lavoro <i>Inboard for fishing and merchants vessels</i>
62.00679.00	530cc	60mm	30mm		2195kg	250mm	
62.00680.00	783cc	65mm	30mm		2611kg	300mm	
62.00702.00	236cc	40mm	25mm		1472kg	160mm	
62.00683.00	1130cc	80mm	40mm		3678kg	300mm	
62.00684.00	1530cc	90mm	40mm		5102kg	300mm	
62.00689.00	339cc	50mm	25mm		1473kg	230mm	
62.00690.00	442cc	50mm	25mm		1473kg	300mm	
62.00691.00	530cc	60mm	30mm		2119kg	250mm	
62.00692.00	783cc	65mm	30mm		2611kg	300mm	
62.00685.00	339cc					250mm	
62-00686.00	445cc					300mm	
62.00687.00	530cc					250mm	
62.00688.00	783cc					300mm	

Utilizzare per il collegamento tubi in rame o flessibili Riviera.

Use flexible Riviera hoses or copper tubes to connect steering helm and cylinder and twin steering station installations.



SCHEMA DI IMPIANTO A STAZIONE FISSA SINGLE STEERING STATION DIAGRAM

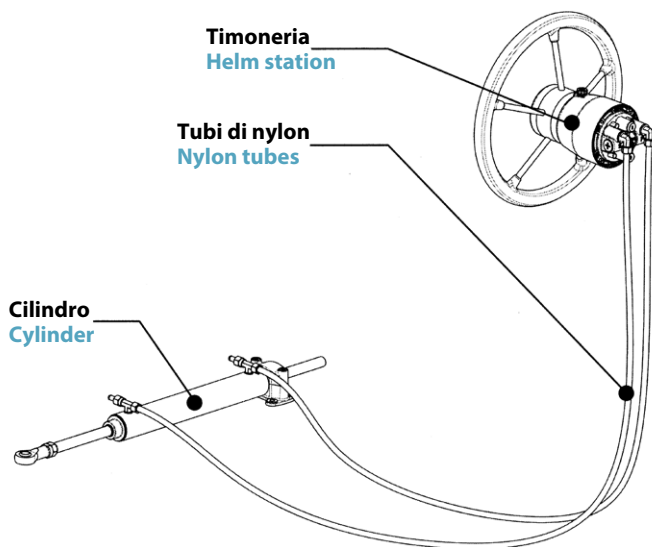

ATTENZIONE:

Nelle installazioni che impiegano pistone entrobordo e tubazioni in rame (diam. 9.5 mm (3/8"), l'ultimo tratto di collegamento (al cilindro) deve essere realizzato con il Kit **tubi flessibili**.

CAUTION:

For inboard steering cylinder installation using diam. 9.5 mm (3/8") nylon tubing, use RIVIERA flexible hose kit to connect cylinder end of hydraulic hose

SCHEMA DI IMPIANTO A STAZIONE MULTIPLA MULTIPLE STEERING STATION DIAGRAM

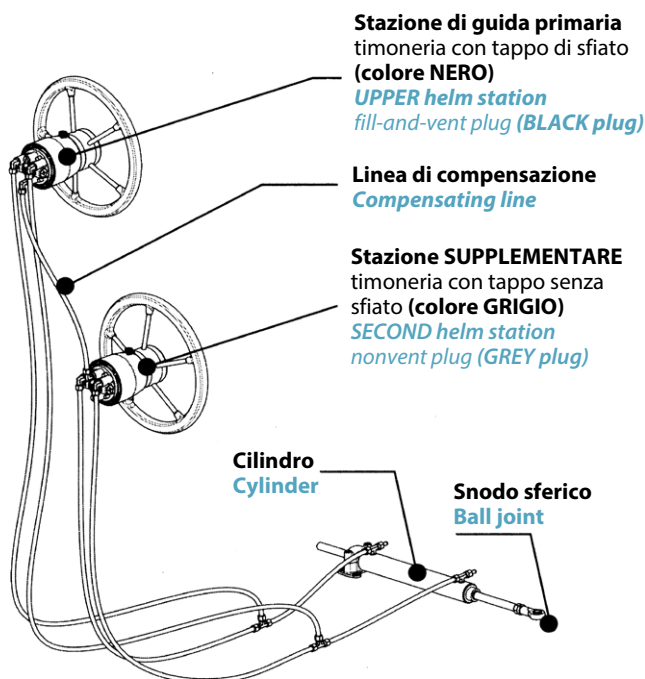

ATTENZIONE:

assicurarsi della presenza del tappo senza sfiato GRIGIO. La sua mancanza potrebbe provocare perdita di olio dal circuito e conseguente mal funzionamento.

CAUTION:

Ensure GREY nonvent plug is in use, to avoid oil leaks and subsequent system malfunction.

DESCRIZIONE / DESCRIPTION

Raccordo intermedio 10/8 1/4"
Hose union 10/8 1/4"

prezzo a conf. 5 PZ.
price per 5 pieces package



COD.ORDINAZIONE / ORDER COD.
62.00706.00

DESCRIZIONE / DESCRIPTION

Raccordo a T centrale 10/8 1/4"
T union 10/8 1/4"

prezzo a conf. 5 PZ.
price per 5 pieces package



COD.ORDINAZIONE / ORDER COD.
62.00709.00

DESCRIZIONE / DESCRIPTION

Anima di rinforzo 10/8
Cap plug 10/8

prezzo a conf. 5 PZ.
price per 5 pieces package



COD.ORDINAZIONE / ORDER COD.
62.00711.00

DESCRIZIONE / DESCRIPTION

Raccordo dritto 10/8 1/4" F/F
Connector fitting F/F 10/8 1/4"

prezzo a conf. 5 PZ.
price per 5 pieces package



COD.ORDINAZIONE / ORDER COD.
62.00713.00

DESCRIZIONE / DESCRIPTION

Raccordo dritto 3/8" nichelato
Nickel-plated connector fitting 3/8"

prezzo a conf. 5 PZ.
price per 5 pieces package



COD.ORDINAZIONE / ORDER COD.
62.00607.00

DESCRIZIONE / DESCRIPTION

Raccordo a T 3/8" nichelato
Nickel-plated T union 3/8"

prezzo a conf. 5 PZ.
price per 5 pieces package



COD.ORDINAZIONE / ORDER COD.
62.00609.00

DESCRIZIONE / DESCRIPTION

Raccordo a gomito 10/8 1/4"
Elbow fitting 10/8 1/4"

prezzo a conf. 5 PZ.
price per 5 pieces package



COD.ORDINAZIONE / ORDER COD.
62.00707.00

DESCRIZIONE / DESCRIPTION

Raccordo a T intermedio 10/8
T union 10/8 1/4"

prezzo a conf. 5 PZ.
price per 5 pieces package



COD.ORDINAZIONE / ORDER COD.
62.00710.00

DESCRIZIONE / DESCRIPTION

Raccordo dritto 10/8 1/4" F/M
Connector fitting F/M 10/8 1/4"

prezzo a conf. 5 PZ.
price per 5 pieces package



COD.ORDINAZIONE / ORDER COD.
62.00712.00

DESCRIZIONE / DESCRIPTION

Valvola a sfera 10/8 1/4" F/F
Ball valve F/F 10/8 1/4"

prezzo a conf. 5 PZ.
price per 5 pieces package



COD.ORDINAZIONE / ORDER COD.
62.00714.00

DESCRIZIONE / DESCRIPTION

Raccordo a gomito 3/8" nichelato
Nickel-plated elbow fitting 3/8"

prezzo a conf. 5 PZ.
price per 5 pieces package



COD.ORDINAZIONE / ORDER COD.
62.00608.00

DESCRIZIONE / DESCRIPTION

Raccordo a cilindro a T per spurgo 3/8" nichelato
Bleed T for cylinder nickel-plated 3/8"

prezzo a conf. 5 PZ.
price per 5 pieces packages

COD.ORDINAZIONE / ORDER COD.
62.00610.00





DESCRIZIONE / DESCRIPTION

Dado con ogiva
Nut and sleeve assembly

prezzo a conf. 4 PZ
price per 4 pieces package



COD.ORDINAZIONE / ORDER COD.

62.00621.00

DESCRIZIONE / DESCRIPTION

Kit per applicazione
tubo rame d.10
Copper tube fitting kit Diam.10



COD.ORDINAZIONE / ORDER COD.

62.00624.00

DESCRIZIONE / DESCRIPTION

Valvola
By-pass



COD.ORDINAZIONE / ORDER COD.

62.00626.00

DESCRIZIONE / DESCRIPTION

Raccordo recuperabile per
tubo rinforzato flessibile 5/16"
Connection recoverable for
reinforced flexible hose 5/16"



prezzo a conf. 4 PZ
price per 4 pieces package

COD.ORDINAZIONE / ORDER COD.

62.00771.00

DESCRIZIONE / DESCRIPTION

Kit guarnizioni per cilindro
fuoribordo 350 HP
350 HP outboard cylinder
Head Gasket kit



COD.ORDINAZIONE / ORDER COD.

61.01129.00

DESCRIZIONE / DESCRIPTION

Kit guarnizioni per cilindro
fuoribordo 250 HP
250 HP outboard cylinder
Head Gasket kit



COD.ORDINAZIONE / ORDER COD.

61.01132.00

DESCRIZIONE / DESCRIPTION

Kit di riempimento
Filling kit



COD.ORDINAZIONE / ORDER COD.

62.00597.00

DESCRIZIONE / DESCRIPTION

Kit stazione aggiuntiva
Second steering fitting kit



COD.ORDINAZIONE / ORDER COD.

62.00625.00

DESCRIZIONE / DESCRIPTION

Serie raccordi per
tubo rame 3/8"
Copper tube fittings 3/8"



COD.ORDINAZIONE / ORDER COD.

62.00627.00

DESCRIZIONE / DESCRIPTION

Barra accoppiamento 480/615 mm
TIE bar 480/615 mm



COD.ORDINAZIONE / ORDER COD.

62.00776.00

DESCRIZIONE / DESCRIPTION

Hydrax 32 - 1 lt
Hydrax 32 - 1 lt



COD.ORDINAZIONE / ORDER COD.

62.00604.00



COD.ORDINAZIONE / **ORDER COD.**

62.00619.00 Tubo rinforzato flessibile R7 5/16"
Reinforced flexible hose R7 5/16"

prezzo al metro / *price per meter*



COD.ORDINAZIONE / **ORDER COD.**

62.00620.00 Tubo rinforzato 3/8"
Reinforced hose 3/8"

prezzo al metro / *price per meter*



COD.ORDINAZIONE / **ORDER COD.**

62.00603.30 Tubo flessibile con raccordi preassemblati mt 3,00
Flexible hose with preassembled fittings mt 3,00

62.00603.35 Tubo flessibile con raccordi preassemblati mt 3,50
Flexible hose with preassembled fittings mt 3,50

62.00603.40 Tubo flessibile con raccordi preassemblati mt 4,00
Flexible hose with preassembled fittings mt 4,00

62.00603.45 Tubo flessibile con raccordi preassemblati mt 4,50
Flexible hose with preassembled fittings mt 4,50

62.00603.50 Tubo flessibile con raccordi preassemblati mt 5,00
Flexible hose with preassembled fittings mt 5,00

62.00603.55 Tubo flessibile con raccordi preassemblati mt 5,50
Flexible hose with preassembled fittings mt 5,50

62.00603.60 Tubo flessibile con raccordi preassemblati mt 6,00
Flexible hose with preassembled fittings mt 6,00

62.00603.65 Tubo flessibile con raccordi preassemblati mt 6,50
Flexible hose with preassembled fittings mt 6,50

62.00603.70 Tubo flessibile con raccordi preassemblati mt 7,00
Flexible hose with preassembled fittings mt 7,00

62.00603.75 Tubo flessibile con raccordi preassemblati mt 7,50
Flexible hose with preassembled fittings mt 7,50

62.00603.80 Tubo flessibile con raccordi preassemblati mt 8,00
Flexible hose with preassembled fittings mt 8,00

62.00603.85 Tubo flessibile con raccordi preassemblati mt 8,50
Flexible hose with preassembled fittings mt 8,50

62.00603.90 Tubo flessibile con raccordi preassemblati mt 9,00
Flexible hose with preassembled fittings mt 9,00



Riviera

VOLANTI
STEERING WHEELS

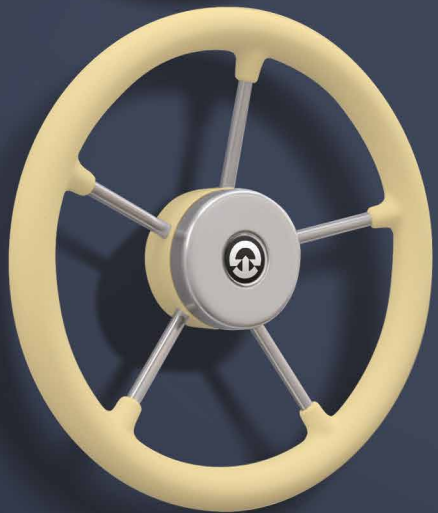

STEERING WHEELS

VR01

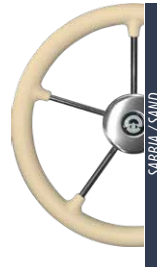

DESCRIZIONE / DESCRIPTION

Diametro / Diameter: 325 / 325

Impugnatura / Grip: Megol / Megol

Razze / Spokes: Acciaio inox / Stainless steel

Cert. di esame CE in accordo con le direttive 2013/53/EU

Exam Certification CE according to the directive 2013/53/EU SAFETY STANDARDS.

CODICE ORDINAZIONE / ORDER CODES

- 62.00538.00 Nero / Black
- 62.00538.01 Bianco / White
- 62.00538.02 Grigio / Grey
- 62.00538.03 Sabbia / Sand

Mozzo del volante non soggetto a corrosione
Corrosion free Steering wheel hub

VR02



DESCRIZIONE / DESCRIPTION

Diametro / Diameter: 350 / 350

Impugnatura / Grip: Megol / Megol

Razze / Spokes: Acciaio inox / Stainless steel

Cert. di esame CE in accordo con le direttive 2013/53/EU

Exam Certification CE according to the directive 2013/53/EU SAFETY STANDARDS.

CODICE ORDINAZIONE / ORDER CODES

- 62.00499.00 Nero / Black
- 62.00499.01 Bianco / White
- 62.00499.02 Grigio / Grey
- 62.00499.03 Sabbia / Sand

Mozzo del volante non soggetto a corrosione
Corrosion free Steering wheel hub

VR03



DESCRIZIONE / DESCRIPTION

Diametro / Diameter: 400 / 400

Impugnatura / Grip: Megol / Megol

Razze / Spokes: Acciaio inox / Stainless steel

Cert. di esame CE in accordo con le direttive 2013/53/EU

Exam Certification CE according to the directive 2013/53/EU SAFETY STANDARDS.

CODICE ORDINAZIONE / ORDER CODES

- 62.00497.00 Nero / Black
- 62.00497.01 Bianco / White
- 62.00497.02 Grigio / Grey

Mozzo del volante non soggetto a corrosione
Corrosion free Steering wheel hub



VR00

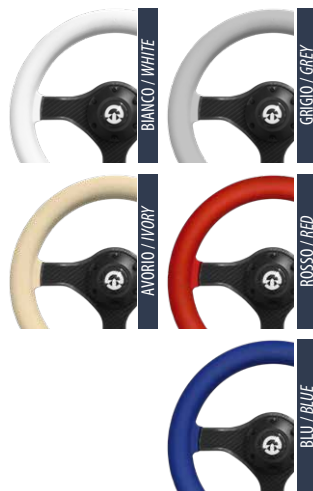

DESCRIZIONE / DESCRIPTION

Diametro / Diameter: 280 / 280

Impugnatura / Grip: Megol effetto pelle / Megol leather effect

Razze / Spokes: PP effetto carbonio / PP carbon effect

CODICE ORDINAZIONE / ORDER CODES

- 62.00784.00** Nero / Black
- 62.00784.01** Bianco / White
- 62.00784.02** Grigio / Grey
- 62.00784.03** Avorio / Ivory
- 62.00784.04** Rosso / Red
- 62.00784.05** Blu / Blue

Mozzo del volante non soggetto a corrosione
Corrosion free Steering wheel hub

Conforme alle normative UNI EN 28848
UNI EN 29775 - UNI EN ISO 10592
Mozzo con attacco universale.

In conformity with the UNI EN 28848
UNI EN 29775 - UNI EN ISO 10592 STANDARDS.
about leisure boats. Standard Hub.

VR04



DESCRIZIONE / DESCRIPTION

Diametro / Diameter: 350 / 350

Impugnatura / Grip: Megol effetto pelle / Megol leather effect

Razze / Spokes: PP effetto carbonio / PP carbon effect

CODICE ORDINAZIONE / ORDER CODES

- 62.00863.00** Nero / Black
- 62.00863.01** Bianco / White
- 62.00863.02** Grigio / Grey

Mozzo del volante non soggetto a corrosione
Corrosion free Steering wheel hub

Conforme alle normative UNI EN 28848
UNI EN 29775 - UNI EN ISO 10592
Mozzo con attacco universale.

In conformity with the UNI EN 28848
UNI EN 29775 - UNI EN ISO 10592 STANDARDS.
about leisure boats. Standard Hub.

VS01



DESCRIZIONE / DESCRIPTION

Diametro / Diameter: 350 / 350

Impugnatura / Grip: Poliuretano-Mogano-Teak / Polyurethane-Mahogany-Teak

Razze / Spokes: Acciaio inox / Stainless steel

CODICE ORDINAZIONE / ORDER CODES

- 62.00722.00 Nero / Black
- 62.00722.01 Grigio / Grey
- 62.00722.02 Bianco / White
- 62.00722.03 Avorio / Ivory
- 62.00722.04 Mogano / Mahogany
- 62.00722.05 Teak / Teak

Cert.di esame CE tipo N.DIP 26897
Conforme alle normative
UNI EN 28848 - UNI EN 29775

In conformity with the UNI EN 28848
UNI EN 29775 - UNI EN ISO 10592 STANDARDS.

VS02



DESCRIZIONE / DESCRIPTION

Diametro / Diameter: 350 / 350

Impugnatura / Grip: Poliuretano-Carbonio-Inox-Mogano / Polyurethane-Carbon-Inox-Mahogany

Razze / Spokes: Acciaio inox / Stainless steel

CODICE ORDINAZIONE / ORDER CODES

- 62.00723.00 Carbonio / Carbon
- 62.00723.01 Inox / Inox
- 62.00723.02 Mogano / Mahogany
- 62.00723.03 Bianco / White
- 62.00723.04 Nero / Black
- 62.00723.05 Avorio / Ivory

Cert.di esame CE tipo N.DIP 26897
Conforme alle normative
UNI EN 28848 - UNI EN 29775

In conformity with the UNI EN 28848
UNI EN 29775 - UNI EN ISO 10592 STANDARDS.



VS03



DESCRIZIONE / DESCRIPTION

Diametro / Diameter: 350 / 350

Impugnatura / Grip: Mogano-Poliuretano / Mahogany-Polyurethane

Razze / Spokes: Acciaio inox / Stainless steel

CODICE ORDINAZIONE / ORDER CODES

62.00724.00 Mogano / Mahogany

62.00724.01 Bianco / White

62.00724.02 Avorio / Ivory

62.00724.03 Grigio / Grey

62.00724.04 Nero / Black

Cert.di esame CE tipo N.DIP 26897

Conforme alle normative

UNI EN 28848 - UNI EN 29775

In conformity with the UNI EN 28848

UNI EN 29775 - UNI EN ISO 10592 STANDARDS.

VS11



DESCRIZIONE / DESCRIPTION

Diametro / Diameter: 350 / 350

Impugnatura / Grip: Poliuretano / Polyurethane

Razze / Spokes: Alluminio anodizzato / Anodized aluminum

CODICE ORDINAZIONE / ORDER CODES

62.00838.00 Nero / Black

62.00838.01 Bianco / White

62.00838.02 Avorio / Ivory

Cert.di esame CE tipo N.DIP 26897

Conforme alle normative

UNI EN 28848 - UNI EN 29775

In conformity with the UNI EN 28848

UNI EN 29775 - UNI EN ISO 10592 STANDARDS.

VS12



DESCRIZIONE / DESCRIPTION

Diametro / Diameter: 350 / 350

Impugnatura / Grip: Poliuretano-Mogano-Inox / Polyurethane-Mahogany-inox

Razze / Spokes: Acciaio inox / Stainless steel

CODICE ORDINAZIONE / ORDER CODES

- 62.00839.00** Nero / Black
- 62.00839.01** Bianco / White
- 62.00839.02** Avorio / Ivory
- 62.00839.03** Grigio / Grey
- 62.00839.04** Mogano / Mahogany
- 62.00839.05** Inox / Inox

Cert.di esame CE tipo N.DIP 26897
Conforme alle normative
UNI EN 28848 - UNI EN 29775

In conformity with the UNI EN 28848
UNI EN 29775 - UNI EN ISO 10592 STANDARDS.

VS13



DESCRIZIONE / DESCRIPTION

Diametro / Diameter: 350 / 350

Impugnatura / Grip: Poliuretano / Polyurethane

Razze / Spokes: Acciaio inox / Stainless steel

CODICE ORDINAZIONE / ORDER CODES

- 62.00840.00** Nero / Black
- 62.00840.01** Bianco / White
- 62.00840.02** Avorio / Ivory
- 62.00840.03** Grigio / Grey
- 62.00840.04** Mogano / Mahogany

Cert.di esame CE tipo N.DIP 26897
Conforme alle normative
UNI EN 28848 - UNI EN 29775

In conformity with the UNI EN 28848
UNI EN 29775 - UNI EN ISO 10592 STANDARDS.



Riviera

COMANDI
LEVER CONTROLS



LEVER CONTROL

CM01**CM02****CM01****CARATTERISTICHE/ KEY FEATURES**

Installazione / <i>Installation:</i>	Parete / <i>Wall mount</i>
Sicurezza / <i>Safety:</i>	Meccanica / <i>Mechanical</i>
Corsa accel. / <i>Accelerator stroke:</i>	88 / 88
Corsa invertitore / <i>Inverter stroke:</i>	68 - 76 / 68 - 76

CODICI ORDINAZIONE / ORDER CODES

62.00008.01 CM01	Nera / <i>Black</i>
62.00008.02 CM01	Bianca / <i>White</i>

Compatibili con cavi RIVIERA modello F14/F05 e, con adattatore fornito di serie, con cavi modello F02/F08.
For use with riviera F14/F05 cables, for use with riviera F02/F08 cables - the adaptor is included.

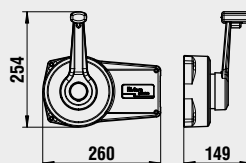

Direzione acceleratore reversibile.
 Accelerazione in folle per riscaldamento motore.
 Realizzate in materiali speciali Delrin 100, Eltex e bxf, resistenti all'usura agenti atmosferici.
 Parti accessorie in acciaio inossidabile.

Reversible accelerator direction. Neutral throttle warm-up. Made of wear and atmospheric agents resistant materials. Stainless steel accessory parts.

CM02**CARATTERISTICHE/ KEY FEATURES**

Installazione / <i>Installation:</i>	Incasso / <i>Flush mount</i>
Sicurezza / <i>Safety:</i>	Meccanica / <i>Mechanical</i>
Corsa accel. / <i>Accelerator stroke:</i>	88 / 88
Corsa invertitore / <i>Inverter stroke:</i>	68 - 76 / 68 - 76

CODICI ORDINAZIONE / ORDER CODES

62.00007.01 CM02	Nera / <i>Black</i>
62.00007.02 CM02	Bianca / <i>White</i>

Compatibili con cavi RIVIERA modello F14/F05 e, con adattatore fornito di serie, con cavi modello F02/F08.
For use with riviera F14/F05 cables, for use with riviera F02/F08 cables - the adaptor is included.

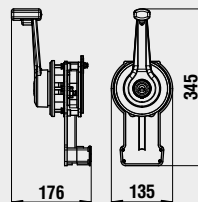

Direzione acceleratore reversibile.
 Accelerazione in folle per riscaldamento motore.
 Realizzate in materiali speciali Delrin 100, Eltex e bxf, resistenti all'usura agenti atmosferici.
 Parti accessorie in acciaio inossidabile.

Reversible accelerator direction. Neutral throttle warm-up. Made of wear and atmospheric agents resistant materials. Stainless steel accessory parts.





CM03



CM03

CARATTERISTICHE/ KEY FEATURES

Installazione / <i>Installation:</i>	Incasso / <i>Flush mount</i>
Sicurezza/ <i>Safety:</i>	Meccanica / <i>Mechanical</i>
Corsa accel. / <i>Accelerator stroke:</i>	88 / 88
Corsa invertitore / <i>Inverter stroke:</i>	68 - 76 / 68 - 76

CODICI ORDINAZIONE / ORDER CODES

62.00010.01 CM03 Nera / *Black*
62.00010.02 CM03 Bianca / *White*

Compatibili con cavi RIVIERA modello F14/F05 e, con adattatore fornito di serie, con cavi modello F02/F08.
For use with riviera F14/F05 cables, for use with riviera F02/F08 cables - the adaptor is included.

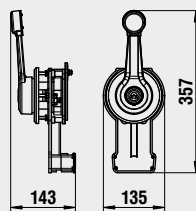

Direzione acceleratore reversibile.
 Accelerazione in folle per riscaldamento motore.
 Realizzate in materiali speciali Delrin 100, Eltex e Ixef, resistenti all'usura agenti atmosferici.
 Parti accessorie in acciaio inossidabile.

Reversible accelerator direction. Neutral throttle warm-up. Made of wear and atmospheric agents resistant materials. Stainless steel accessory parts.

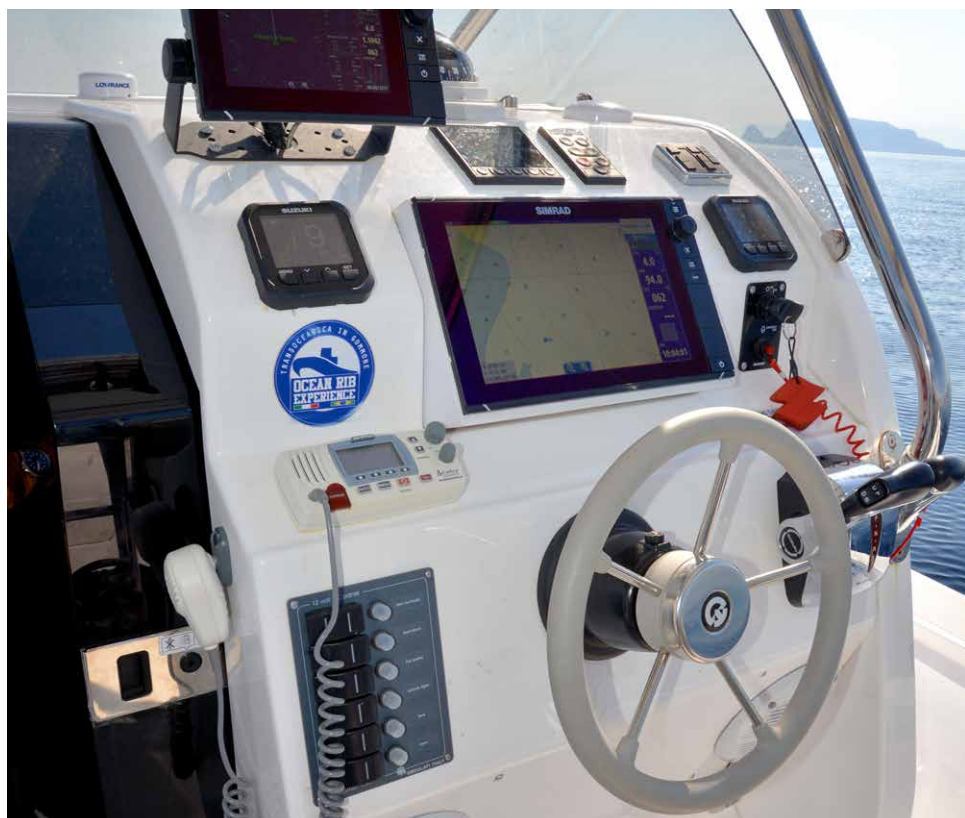

CM04**CM05****CM04****CARATTERISTICHE/ KEY FEATURES**

Installazione / <i>Installation:</i>	Cruscotto / <i>Top mount</i>
Sicurezza/ <i>Safety:</i>	Elettrica / <i>Electrical</i>
Corsa accel. / <i>Accelerator stroke:</i>	63 / <i>63</i>
Corsa invertitore / <i>Inverter stroke:</i>	68,5 - 75 - 82 / <i>68,5 - 75- 82</i>

CODICI ORDINAZIONE / ORDER CODES**62.00540.00** Monoleva singola / *One lever*

Compatibili, con adattatore fornito di serie, con cavi modello F02/F08.

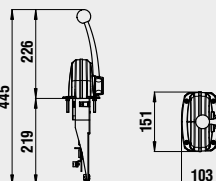
For use with Riviera F02/F08 cables - the adaptor is included.

Direzione acceleratore reversibile. Accelerazione in folle per riscaldamento motore. Realizzate in zama, ramate e cromate secondo specifiche RIVIERA. Parti accessorie in acciaio inossidabile. Dotate di dispositivo antiavviamento in conformità alla normativa UNI-EN 11547.

Reversible accelerator direction. Neutral throttle warm-up. Made of wear and atmospheric agents resistant materials. Stainless steel accessory parts.

CM05**CARATTERISTICHE/ KEY FEATURES**

Installazione / <i>Installation:</i>	Cruscotto / <i>Top mount</i>
Sicurezza/ <i>Safety:</i>	Elettrica / <i>Electrical</i>
Corsa accel. / <i>Accelerator stroke:</i>	63 / <i>63</i>
Corsa invertitore / <i>Inverter stroke:</i>	68,5 - 75 - 82 / <i>68,5 - 75- 82</i>

CODICI ORDINAZIONE / ORDER CODES**62.00541.00** Monoleva doppia / *Two lever*

Compatibili, con adattatore fornito di serie, con cavi modello F02/F08.

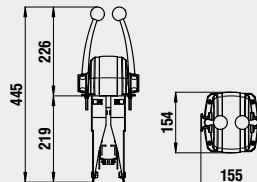
For use with Riviera F02/F08 cables - the adaptor is included.

Direzione acceleratore reversibile. Accelerazione in folle per riscaldamento motore. Realizzate in zama, ramate e cromate secondo specifiche RIVIERA. Parti accessorie in acciaio inossidabile. Dotate di dispositivo antiavviamento in conformità alla normativa UNI-EN 11547.

Reversible accelerator direction. Neutral throttle warm-up. Made of wear and atmospheric agents resistant materials. Stainless steel accessory parts.

**CB01****CB02****INVERTITORE / SHIFT****ACCELERATORE / THROTTLE**SX LEVA SINISTRA / *LEFT LEVER*DX LEVA DESTRA / *RIGHT LEVER*

BLOCCO fermo meccanico che impedisce l'inserimento della marcia con acceleratore in posizione diversa dal minimo.

BLOCK mechanical stop that prevents the insertion of the gear with throttle position other than the minimum

**CB01 Leve dritte / Straight Levers**

Direzione acceleratore reversibile.
Leve realizzate in zama, ramate e cromate secondo specifiche RIVIERA.
Parti accessorie in acciaio inossidabile.
Dotate di dispositivo antiavviamento in conformità alla normativa EN 11547.

*Reversible accelerator direction.
Made of zamak copper plated and chromium plated according to Riviera specifications.
Stainless steel accessory parts.
With anti starting device in conformity with EN 11547 safety standards.*

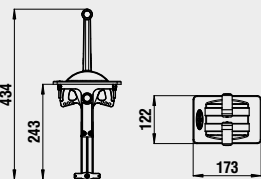
**CARATTERISTICHE/ KEY FEATURES**

Installazione / <i>Installation:</i>	Incasso / <i>Flush mount</i>
Sicurezza/ <i>Safety:</i>	Secondo modello / <i>The model that need</i>
Corsa accel. / <i>Accelerator stroke:</i>	53 - 66 - 78 / <i>53 - 66 - 78</i>
Corsa invertitore / <i>Inverter stroke:</i>	53 - 66 - 78 / <i>53 - 66 - 78</i>

Accessori / Accessories**COD. ORDINAZIONE / ORDER COD.**

		60.02676.00 Base nera / <i>Black grill</i>
		60.02676.01 Base bianca / <i>White grill</i>

SX DX CODICI ORDINAZIONE / ORDER CODES

● ●	62.00556.00	Acc/Inv-C/blocco - Base nera / <i>Throttle Shift - safety block - black</i>
● ●	62.00556.01	Acc/Inv-C/blocco - Base bianca / <i>Throttle Shift - safety block - white</i>
● ●	62.00556.20	Inv/Inv - Base nera / <i>Shift/Shift - black</i>
● ●	62.00556.21	Inv/Inv - Base bianca / <i>Shift/Shift - white</i>
● ●	62.00556.30	Acc/Acc - Base nera / <i>Throttle/throttle - black</i>
● ●	62.00556.31	Acc/Acc - Base bianca / <i>Throttle/throttle - white</i>
● ●	62.00556.40	Inv/Acc - C/blocco - Base nera / <i>Shift/throttle - safety block - black</i>
● ●	62.00556.41	Inv/Acc-C/blocco Base bianca / <i>Shift/throttle - safety block - white</i>

Compatibili, con adattatore fornito di serie, con cavi modello F02/F08 / *For use with Riviera F02/F08 cables - the adaptor is included.*

CB02 Leve inclinate / Bent Levers

Direzione acceleratore reversibile.
Accelerazione in folle per riscaldamento motore.
Realizzate in zama, ramate e cromate secondo specifiche RIVIERA.
Parti accessorie in acciaio inossidabile.
Dotate di dispositivo antiavviamento in conformità alla normativa EN 11547.

*Reversible accelerator direction.
Made of zamak copper plated and chromium plated according to Riviera specifications.
Stainless steel accessory parts.
With anti starting device in conformity with EN 11547 safety standards.*

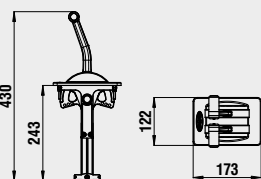
**CARATTERISTICHE/ KEY FEATURES**

Installazione / <i>Installation:</i>	Incasso / <i>Flush mount</i>
Sicurezza/ <i>Safety:</i>	Secondo modello / <i>The model that need</i>
Corsa accel. / <i>Accelerator stroke:</i>	53 - 66 - 78 / <i>53 - 66 - 78</i>
Corsa invertitore / <i>Inverter stroke:</i>	53 - 66 - 78 / <i>53 - 66 - 78</i>

Accessori / Accessories**COD. ORDINAZIONE / ORDER COD.**

		60.02676.00 Base nera / <i>Black grill</i>
		60.02676.01 Base bianca / <i>White grill</i>

SX DX CODICI ORDINAZIONE / ORDER CODES

● ●	62.00545.00	Acc/Inv-C/blocco - Base nera / <i>Throttle Shift - safety block - black</i>
● ●	62.00545.01	Acc/Inv-C/blocco - Base bianca / <i>Throttle Shift - safety block - white</i>
● ●	62.00545.20	Inv/Acc - C/blocco - Base nera / <i>Shift/throttle - safety block - black</i>
● ●	62.00545.21	Inv/Acc-C/blocco Base bianca / <i>Shift/throttle - safety block - white</i>
● ●	62.00545.40	Inv/Inv - Base nera / <i>Shift/Shift - black</i>
● ●	62.00545.41	Inv/Inv - Base bianca / <i>Shift/Shift - white</i>
● ●	62.00545.50	Acc/Acc - Base nera / <i>Throttle/throttle - black</i>
● ●	62.00545.51	Acc/Acc - Base bianca / <i>Throttle/throttle - white</i>

Compatibili, con adattatore fornito di serie, con cavi modello F02/F08 / *For use with Riviera F02/F08 cables - the adaptor is included.*

CB03



CB04



■ **INVERTITORE / SHIFT**

■ **ACCELERATORE / THROTTLE**

SX LEVA SINISTRA / *LEFT LEVER*

DX LEVA DESTRA / *RIGHT LEVER*

BLOCCO fermo meccanico che impedisce l'inserimento della marcia con acceleratore in posizione diversa dal minimo.

BLOCK mechanical stop that prevents the insertion of the gear with throttle position other than the minimum

CB03 Sport - leve combinate / Sport - combined levers

Direzione acceleratore reversibile.
Leve realizzate in zama, ramate e cromate secondo specifiche RIVIERA.
Parti accessorie in acciaio inossidabile.
Dotate di dispositivo antiavviamento in conformità alla normativa EN 11547.

*Reversible accelerator direction.
Made of zamak copper plated and chromium plated according to Riviera specifications.
Stainless steel accessory parts.
With anti starting device in conformity with EN 11547 safety standards.*

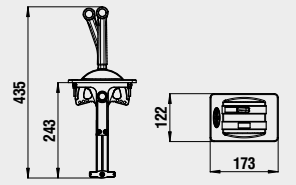

CARATTERISTICHE/ KEY FEATURES

Installazione / <i>Installation:</i>	Incasso / <i>Flush mount</i>
Sicurezza/ <i>Safety:</i>	Secondo modello / <i>The model that need</i>
Corsa accel. / <i>Accelerator stroke:</i>	53 - 66 - 78 / <i>53 - 66 - 78</i>
Corsa invertitore / <i>Inverter stroke:</i>	53 - 66 - 78 / <i>53 - 66 - 78</i>

Accessori / Accessories

COD. ORDINAZIONE / ORDER COD.

		60.02676.00 Base nera / <i>Black grill</i>
		60.02676.01 Base bianca / <i>White grill</i>

SX | DX CODICI ORDINAZIONE / ORDER CODES

● ●	62.00571.00	Acc/Inv-C/blocco - Base nera / <i>Throttle Shift - safety block - black</i>
● ●	62.00571.01	Acc/Inv-C/blocco - Base bianca / <i>Throttle Shift - safety block - white</i>
● ●	62.00571.20	Inv/Acc - C/blocco - Base nera / <i>Shift/throttle - safety block - black</i>
● ●	62.00571.21	Inv/Acc-C/blocco Base bianca / <i>Shift/throttle - safety block - white</i>
● ●	62.00571.40	Inv/Inv - Base nera / <i>Shift/Shift - black</i>
● ●	62.00571.41	Inv/Inv - Base bianca / <i>Shift/Shift - white</i>
● ●	62.00571.50	Acc/Acc - Base nera / <i>Throttle/throttle - black</i>
● ●	62.00571.51	Acc/Acc - Base bianca / <i>Throttle/throttle - white</i>

Compatibili, con adattatore fornito di serie, con cavi modello F02/F08 / *For use with Riviera F02/F08 cables - the adaptor is included.*

CB04 Sport - leve diritte / Sport - straight levers

Direzione acceleratore reversibile.
Leve realizzate in zama, ramate e cromate secondo specifiche RIVIERA.
Parti accessorie in acciaio inossidabile.
Dotate di dispositivo antiavviamento in conformità alla normativa EN 11547.

*Reversible accelerator direction.
Made of zamak copper plated and chromium plated according to Riviera specifications.
Stainless steel accessory parts.
With anti starting device in conformity with EN 11547 safety standards.*

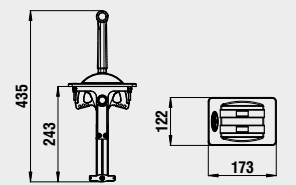

CARATTERISTICHE/ KEY FEATURES

Installazione / <i>Installation:</i>	Incasso / <i>Flush mount</i>
Sicurezza/ <i>Safety:</i>	Secondo modello / <i>The model that need</i>
Corsa accel. / <i>Accelerator stroke:</i>	53 - 66 - 78 / <i>53 - 66 - 78</i>
Corsa invertitore / <i>Inverter stroke:</i>	53 - 66 - 78 / <i>53 - 66 - 78</i>

Accessori / Accessories

COD. ORDINAZIONE / ORDER COD.

		60.02676.00 Base nera / <i>Black grill</i>
		60.02676.01 Base bianca / <i>White grill</i>

SX | DX CODICI ORDINAZIONE / ORDER CODES

● ●	62.00574.00	Inv/Inv - Base nera / <i>Shift/Shift - black</i>
● ●	62.00574.01	Inv/Inv - Base bianca / <i>Shift/Shift - white</i>
● ●	62.00574.10	Acc/Acc - Base nera / <i>Throttle/throttle - black</i>
● ●	62.00574.11	Acc/Acc - Base bianca / <i>Throttle/throttle - white</i>
● ●	62.00574.20	Acc/Inv-C/blocco - Base nera / <i>Throttle Shift - safety block - black</i>
● ●	62.00574.21	Acc/Inv-C/blocco - Base bianca / <i>Throttle Shift - safety block - white</i>
● ●	62.00574.40	Inv/Acc - C/blocco - Base nera / <i>Shift/throttle - safety block - black</i>
● ●	62.00574.41	Inv/Acc-C/blocco Base bianca / <i>Shift/throttle - safety block - white</i>

Compatibili, con adattatore fornito di serie, con cavi modello F02/F08 / *For use with Riviera F02/F08 cables - the adaptor is included.*



CB05



CB06



■ INVERTITORE / SHIFT

■ ACCELERATORE / THROTTLE

SX LEVA SINISTRA / LEFT LEVER

DX LEVA DESTRA / RIGHT LEVER

BLOCCO fermo meccanico che impedisce l'inserimento della marcia con acceleratore in posizione diversa dal minimo.

BLOCK mechanical stop that prevents the insertion of the gear with throttle position other than the minimum

CB05 Sport - leve inclinate / Sport - bent levers

Direzione acceleratore reversibile.
Leve realizzate in zama, ramate e cromate secondo specifiche RIVIERA.
Parti accessorie in acciaio inossidabile.
Dotate di dispositivo antiavviamento in conformità alla normativa EN 11547.

*Reversible accelerator direction.
Made of zamak copper plated and chromium plated according to Riviera specifications.
Stainless steel accessory parts.
With anti starting device in conformity with EN 11547 safety standards.*

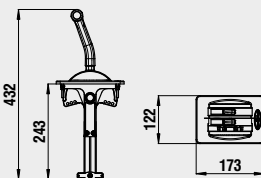

CARATTERISTICHE/ KEY FEATURES

Installazione / <i>Installation:</i>	Incasso / <i>Flush mount</i>
Sicurezza/ <i>Safety:</i>	Secondo modello / <i>The model that need</i>
Corsa accel. / <i>Accelerator stroke:</i>	53 - 66 - 78 / <i>53 - 66 - 78</i>
Corsa invertitore / <i>Inverter stroke:</i>	53 - 66 - 78 / <i>53 - 66 - 78</i>

Accessori / Accessories

COD. ORDINAZIONE / *ORDER COD.*

	60.02676.00 Base nera / <i>Black grill</i>
	60.02676.01 Base bianca / <i>White grill</i>

SX DX CODICI ORDINAZIONE / ORDER CODES

● ●	62.00612.00	Acc/Acc - Base nera / <i>Throttle/throttle - black</i>
● ●	62.00612.01	Acc/Acc - Base bianca / <i>Throttle/throttle - white</i>
● ●	62.00612.10	Inv/Inv - Base nera / <i>Shift/Shift - black</i>
● ●	62.00612.11	Inv/Inv - Base bianca / <i>Shift/Shift - white</i>
● ●	62.00612.20	Inv/Acc - C/blocco - Base nera / <i>Shift/throttle - safety block - black</i>
● ●	62.00612.21	Inv/Acc-C/blocco Base bianca / <i>Shift/throttle - safety block - white</i>
● ●	62.00612.40	Acc/Inv-C/blocco - Base nera / <i>Throttle Shift - safety block - black</i>
● ●	62.00612.41	Acc/Inv-C/blocco - Base bianca / <i>Throttle Shift - safety block - white</i>

Compatibili, con adattatore fornito di serie, con cavi modello F02/F08 / *For use with Riviera F02/F08 cables - the adaptor is included.*

CB06 Leve cromate / Chromium plated levers

Direzione acceleratore reversibile.
Accelerazione in folle per riscaldamento motore.
Realizzate in zama, ramate e cromate secondo specifiche RIVIERA.
Parti accessorie in acciaio inossidabile.
Dotate di dispositivo antiavviamento in conformità alla normativa EN 11547.

*Reversible accelerator direction.
Made of zamak copper plated and chromium plated according to Riviera specifications.
Stainless steel accessory parts.
With anti starting device in conformity with EN 11547 safety standards.*

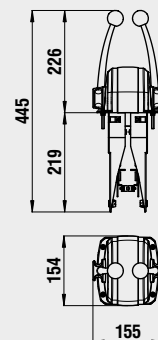

CARATTERISTICHE/ KEY FEATURES

Installazione / <i>Installation:</i>	Cruscotto / <i>Top mount</i>
Sicurezza/ <i>Safety:</i>	Secondo modello / <i>The model that need</i>
Corsa accel. / <i>Accelerator stroke:</i>	68,5 - 75 - 82 / <i>68,5 - 75 - 82</i>
Corsa invertitore / <i>Inverter stroke:</i>	68,5 - 75 - 82 / <i>68,5 - 75 - 82</i>

SX DX CODICI ORDINAZIONE / ORDER CODES

● ●	62.00599.00	Acc/Inv / <i>Throttle Shift</i>
● ●	62.00599.10	Inv/Acc/ <i>Shift/throttle</i>
● ●	62.00599.20	Inv/Inv / <i>Shift/Shift</i>
● ●	62.00599.30	Acc/Acc / <i>Throttle/throttle</i>

Compatibili, con adattatore fornito di serie, con cavi modello F02/F08 / *For use with Riviera F02/F08 cables - the adaptor is included.*



Riviera

CAVI CONTROLLO MOTORE
ENGINE CONTROL CABLES



ENGINE CONTROL CABLES



GUIDA ALLA SCELTA DELLA LUNGHEZZA DEI CAVI FLESSIBILI PER L'INSTALLAZIONE

PER LE PRIME INSTALLAZIONI, misurare la distanza A+B dalla scatola di comando all'acceleratore e/o invertitore del motore lungo un percorso libero da ostacoli. La misura ricavata, arrotondata al valore intero superiore, sarà la lunghezza del vostro cavo.

Si raccomanda che le curve compiute dai cavi abbiano un raggio minimo di circa 200 mm (8").

Per ottenere la lunghezza dei cavi in piedi, dividere il risultato ottenuto in cm per 30.5 e arrotondate al piede superiore.

Per installazioni con motori fuoribordo è necessario aggiungere 90 cm (3") alla lunghezza ottenuta, per permettere il movimento del motore.

Per i ricambi è sufficiente misurare il cavo che dovete sostituire da un'estremità all'altra.

Per ordinare specificate la lunghezza del cavo in metri o in piedi, arrotondando ai valori interi superiori.

HOW TO MEASURE FOR CONTROL CABLE INSTALLATION

FOR NEW INSTALLATION, measure A + B distance from the control along an unobstructed cable routing to clutch and/or throttle connection.

Round this dimension off to the next whole foot: you will have your cable length.

We recommend that the cable bends have a minimum radius of about 8" (200 mm).

For outboard engine installations, it is necessary to add three feet to the obtained length, in order to allow the engine movement.

To determine the needed length of the REPLACEMENT CABLE, measure it from tip to tip.

When ordering, specify the cable length in feet, rounding the dimension off to the next whole value. If any kit is required to complete the cable connection, consult the appropriate section in this catalogue.

SCELTA DEI CAVI CONTROLLO MOTORE / SELECTION OF ENGINE CONTROL CABLES



SERIE ANTEA CEA01 / ANTEA SERIES CEA01

	MOTORI ENGINE	TRASMISSIONI FLESSIBILI RIVIERA RIVIERA ENGINE CONTROL CABLE
FUORIBORDO OUTBOARD	Mercury Scatole Gen. II	F36 - AS08+KIT
	Mercury Mariner oltre 50 hp (37kW)	F05 F07
	Mariner fino a 50hp (37kW)	F16
	Force Selva Yamaha Suzuki Tohatsu Honda Nissan	F02-F08-AS08
	Johnson Evinrude	dopo il 1979 F14 AS08+KIT - F06
ENTROFUORI BORDO STERNDRIVE	Mer cruiser Scatole Gen.II	F36 - AS08+KIT
	Mer cruiser	F05 - F07
	OMC	dopo il 1979 F14 AS08+KIT - F06
	Volvo Penta Yanmar Volkswagen	F02-F08-AS08
ENTROBORDO FUORIBORDO OUTBOARD INBOARD		F02-F08-AS08

FUORIBORDO / INBOARD

$A+B+3' (90 \text{ cm}) = L$

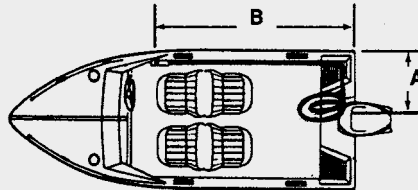

**ENTROBORDO / OUTBOARD
ENTROFUORIBORDO / STERNDRIVE**

$A+B = L$

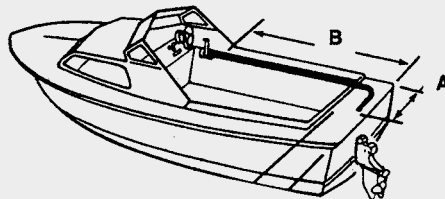



CAVI LOW FRICTION CONTROLLO MOTORE AD ALTA EFFICIENZA E FLESSIBILITÀ

Linea di cavi ad alta efficienza che la **RIVIERA** ha sviluppato per venire incontro alle richieste sempre più crescenti del mercato di cavi "alta scorrevolezza" realizzati in varie configurazioni dei terminali.

LOW FRICTION ENGINE CONTROL CABLE

High efficiency control cables that **RIVIERA** has developed in order to meet the increasing request for "high performance" cables in various configurations

CARATTERISTICHE E PRESTAZIONI / FEATURES AND PERFORMANCE

- **Adatti a tutti i motori fuoribordo, entro-bordo ed entro-fuoribordo.**
Suitable for outboard – inboard and sterndrive engines.
- **Alta scorrevolezza**
High efficiency for smooth operation.
- **Elevata flessibilità che consente ridotti raggi di curvatura, quindi ideale per percorsi particolarmente tortuosi.**
High flexibility for reduced bend radius. Ideal for long complex cable routings.
- **Non necessita di manutenzione**
Maintenance free.
- **Terminali in acciaio inox**
Stainless steel stock.
- **Guaina blu ad alta resistenza all'abrasione, raggi UV e sostanze chimiche.**
High resistance blue outer sheath against abrasion, UV and chemicals

LOW FRICTION (ALTA SCORREVOLEZZA) / LOW FRICTION

- **Le alte prestazioni di questi cavi sono frutto della nostra lunga esperienza nella produzione di trasmissioni flessibili: la formazione speciale del cavo interno permette di ottenere risultati di alta efficienza insieme ad un gioco ridotto, mentre il disegno esclusivo della guaina fornisce un alto livello di flessibilità**
Low friction cables are the result of our decades of experience in producing high quality, long lasting, flexible cables.
The innovative core design maximizes efficiency and minimizes lost motion, while the exclusive design of the conduit provides extremely high level of flexibility.



AS08 UNIVERSALE / *UNIVERSAL*



AS08 + KIT RI57 Utilizzabile su motori JOHNSON® EVINRUDE® OMC®
Suitable for JOHNSON® EVINRUDE® OMC® engine

KIT RI56 KIT di addattamento Cavo F02 F08 ai motori Mercury *Adaptor KIT for Cable F02 F08 on Mercury engines*

CODICI ORDINAZIONE / *ORDER CODES*
62.00764.00

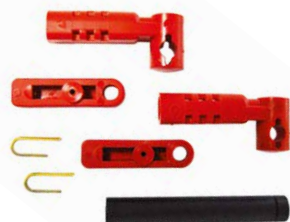

KIT RI57 KIT di adattamento Cavo F02 F08 AS08 ai motori Johnson Evinrude
Adaptor KIT for Cable F02 F08 AS08 on Johnson Evinrude engines

CODICI ORDINAZIONE / ORDER CODES

62.00765.00



AS08



CARATTERISTICHE/ KEY FEATURES

Corsa / Stroke:	87 mm / 87 mm
Diametro guaina / Sheath diameter:	8 mm / 8 mm
Compatibilità / Suitable for:	Universale / Universal

Cavo comando tiro/spinta adatto per installazioni su motori entrobordo, entrofuoribordo e fuoribordo in cui si richiede un'alta efficienza ed elevata flessibilità o con percorsi difficili. Guaina blu.

Pull/Push control cable use with inboard, sterndrive and outboard engines. Ideal for high performance applications. Blue color Sheath.

CODICI ORDINAZIONE / ORDER CODES

62.00755.00

Indicare, al posto delle ultime due cifre, la lunghezza in piedi desiderata
To order the right cable replace the last two number (00) with the feet length required.

PIEDI FEET	METRI METER	PIEDI FEET	METRI METER	PIEDI FEET	METRI METER	PIEDI FEET	METRI METER	PIEDI FEET	METRI METER	PIEDI FEET	METRI METER
05	1,5240	11	3,3528	17	5,1816	23	7,0104	29	8,8392	35	10,6680
06	1,8288	12	3,6576	18	5,4864	24	7,3152	30	9,1440	36	10,9728
07	2,1346	13	3,9624	19	5,7912	25	7,6200	31	9,4488	37	11,2776
08	2,4384	14	4,2672	20	6,0960	26	7,9248	32	9,7536	38	11,5824
09	2,7432	15	4,5720	21	6,4008	27	8,2296	33	10,0584	39	11,8872
10	3,0480	16	4,8768	22	6,7056	28	8,5344	34	10,3632	40	12,1920

AS36 CAVI MERCURY® - MERCUISER® - MARINER®

MERCURY® - MERCUISER® - MARINER® CABLES



CARATTERISTICHE/ KEY FEATURES

Corsa / Stroke:	85 mm / 85 mm
Diametro guaina / Sheath diameter:	8 mm / 8 mm
Compatibilità / Suitable for:	Utilizzabile su motori Mercury® e Mercruiser® e scatole di comando Mercury® serie Generation II™ <i>For Mercury® and Mercruiser® engines and Mercury® Generation II™ series controls.</i>

Cavo di comando tiro/spinta adatto ai motori Mercury e Mercruiser. Terminale in acciaio inox. Parti metalliche in ottone trattato. Alta efficienza, elevata flessibilità, Guaina blu.

Push/Pull control cable for Mercury® and Mercruiser® engines and Mercury® Generation II™ series controls. Stainless steel stop. Treated brass metallic parts. High performance, Blue color

CODICI ORDINAZIONE / ORDER CODES

62.00763.00

Indicare, al posto delle ultime due cifre, la lunghezza in piedi desiderata
To order the right cable replace the last two number (00) with the feet length required.

PIEDI FEET	METRI METER	PIEDI FEET	METRI METER	PIEDI FEET	METRI METER	PIEDI FEET	METRI METER	PIEDI FEET	METRI METER	PIEDI FEET	METRI METER
05	1,5240	11	3,3528	17	5,1816	23	7,0104	29	8,8392	35	10,6680
06	1,8288	12	3,6576	18	5,4864	24	7,3152	30	9,1440	36	10,9728
07	2,1346	13	3,9624	19	5,7912	25	7,6200	31	9,4488	37	11,2776
08	2,4384	14	4,2672	20	6,0960	26	7,9248	32	9,7536	38	11,5824
09	2,7432	15	4,5720	21	6,4008	27	8,2296	33	10,0584	39	11,8872
10	3,0480	16	4,8768	22	6,7056	28	8,5344	34	10,3632	40	12,1920



CAVI FLESSIBILI PER IL CONTROLLO DEL MOTORE

CARATTERISTICHE E PRESTAZIONI / FEATURES AND PERFORMANCE

Disponibili nelle seguenti configurazioni dei terminali / Available in the following configurations

F02 Tipo Universale / *Universal type*

F08 Tipo Universale / *Universal type*

F14 Tipo OMC, Johnson, Evinrude / *OMC, Johnson, Evinrude type*

F06 Tipo OMC, Johnson, Evinrude / *OMC, Johnson, Evinrude type*

F07 Mercury, Mercruiser / *Mercury, Mercruiser type*

F36 Tipo Mercury, Mercruiser, Mariner / *Mercury, Mercruiser, Mariner type*

F05 Tipo Mercury, Mercruiser, Mariner / *Mercury, Mercruiser, Mariner type*

F16 Tipo Mercury, Mercruiser, Mariner / *Mercury, Mercruiser, Mariner type*

- Adatti a tutti i motori fuoribordo, entro-bordo ed entro-fuoribordo.
Suitable for outboard - inboard and sterndrive engines.
- Non necessita di manutenzione.
Maintenance free.
- Terminali in acciaio inox.
Stainless steel stock.
- Guaina nera ad alta resistenza all'abrasione, raggi UV e sostanze chimiche.
High resistance black outer sheath against abrasion, UV and chemicals.

CAVI UNIVERSALI / UNIVERSAL CABLES

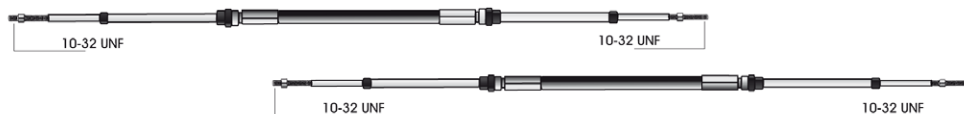

CAVI OMC® - JOHNSON® - EVINRUDE® / OMC® - JOHNSON® - EVINRUDE® CABLES

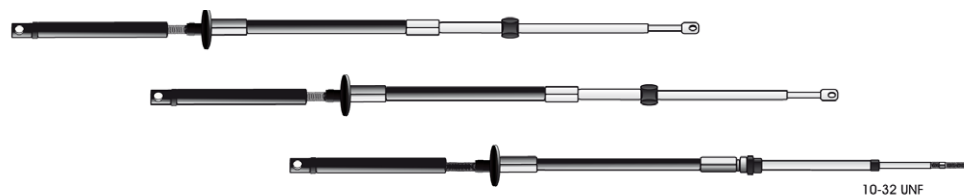

CAVO STOP / STOP CABLE



CAVI MERCURY® - MERCUISER® - MARINER® / MERCURY® - MERCUISER® - MARINER®

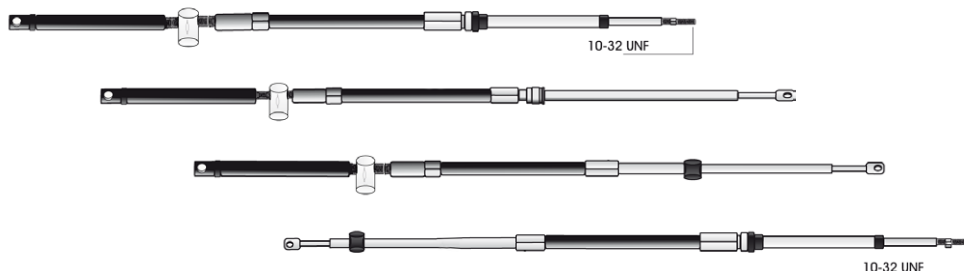

F02 CAVI UNIVERSALI UNIVERSAL CABLES



Terminali in acciaio inox.
Parti metalliche in ottone trattato.
Anima in acciaio inox da 2 mm.
Terminale filettato 10-32 UNF.

Push/Pull control cable suitable for all steering systems helm. Stainless steel stock. Treated brass metallic parts. 2 mm stainless steel cup plug. Threaded terminal 10-32 UNF.

CARATTERISTICHE/ KEY FEATURES

Corsa / Stroke: 88 mm / 88 mm

Diametro guaina / Sheath diameter: 7 mm / 7 mm

Compatibilità / Suitable for: Adatto a tutti i motori entroborordo, entrofuoribordo e fuoribordo mediante gli appositi accessori
For use with inboard, sterndrive and outboard engines, with appropriate accessories.

CODICI ORDINAZIONE / ORDER CODES

62.00000.00

Indicare, al posto delle ultime due cifre, la lunghezza in piedi desiderata
To order the right cable replace the last two number (00) with the feet length required.

PIEDI FEET	METRI METER	PIEDI FEET	METRI METER	PIEDI FEET	METRI METER	PIEDI FEET	METRI METER
05	1,5240	14	4,2672	23	7,0104	32	9,7536
06	1,8288	15	4,5720	24	7,3152	33	10,0584
07	2,1346	16	4,8768	25	7,6200	34	10,3632
08	2,4384	17	5,1816	26	7,9248	35	10,6680
09	2,7432	18	5,4864	27	8,2296	36	10,9728
10	3,0480	19	5,7912	28	8,5344	37	11,2776
11	3,3528	20	6,0960	29	8,8392	38	11,5824
12	3,6576	21	6,4008	30	9,1440	39	11,8872
13	3,9624	22	6,7056	31	9,4488	40	12,1920

F08 CAVI UNIVERSALI UNIVERSAL CABLES



Terminali in acciaio inox.
Parti metalliche in ottone trattato.
Anima in acciaio inox da 2 mm.
Terminale filettato 10-32 UNF.
Indicato per lunghezze elevate.

Push/Pull control cable suitable for all steering systems helm. Stainless steel stock. Treated brass metallic parts. 2 mm stainless steel cup plug. Threaded terminal 10-32 UNF

CARATTERISTICHE/ KEY FEATURES

Corsa / Stroke: 88 mm / 88 mm

Diametro guaina / Sheath diameter: 8 mm / 8 mm

Compatibilità / Suitable for: Adatto a tutti i motori entroborordo, entrofuoribordo e fuoribordo mediante gli appositi accessori
For use with inboard, sterndrive and outboard engines, with appropriate accessories.

CODICI ORDINAZIONE / ORDER CODES

62.00001.00

Indicare, al posto delle ultime due cifre, la lunghezza in piedi desiderata
To order the right cable replace the last two number (00) with the feet length required.

PIEDI FEET	METRI METER	PIEDI FEET	METRI METER	PIEDI FEET	METRI METER	PIEDI FEET	METRI METER
05	1,5240	14	4,2672	23	7,0104	32	9,7536
06	1,8288	15	4,5720	24	7,3152	33	10,0584
07	2,1346	16	4,8768	25	7,6200	34	10,3632
08	2,4384	17	5,1816	26	7,9248	35	10,6680
09	2,7432	18	5,4864	27	8,2296	36	10,9728
10	3,0480	19	5,7912	28	8,5344	37	11,2776
11	3,3528	20	6,0960	29	8,8392	38	11,5824
12	3,6576	21	6,4008	30	9,1440	39	11,8872
13	3,9624	22	6,7056	31	9,4488	40	12,1920



F14 CAVI OMC® - JOHNSON® - EVINRUDE® OMC® - JOHNSON® - EVINRUDE® CABLES



Cavo di comando tiro/spinta adatto ai motori Johnson, Evinrude e OMC di costruzione successiva al 1979. Terminale in acciaio inox. Parti metalliche in ottone trattato. Anima in acciaio inox da 2 mm.

Push/Pull control cable suitable for Johnson, Evinrude engines and OMC engines manufactured from 1979 to date. Stainless steel stock. Treated brass metallic parts. 2 mm stainless steel cup plug.

CARATTERISTICHE/ KEY FEATURES

Corsa / Stroke: 75 mm / 75 mm

Diametro guaina / Sheath diameter: 7 mm / 7 mm

Compatibilità / Suitable for: Utilizzabile su motori Johnson®, Evinrude®, OMC costruiti dal 1979 ad oggi.

For use with inboard, sterndrive and outboard engines, OMC® costruiti dal 1979 ad oggi.

CODICI ORDINAZIONE / ORDER CODES

62.00004.00

Indicare, al posto delle ultime due cifre, la lunghezza in piedi desiderata

To order the right cable replace the last two number (00) with the feet length required.

PIEDI FEET	METRI METER	PIEDI FEET	METRI METER	PIEDI FEET	METRI METER	PIEDI FEET	METRI METER	PIEDI FEET	METRI METER
05	1,5240	13	3,9624	20	6,0960	27	8,2296	34	10,3632
06	1,8288	14	4,2672	21	6,4008	28	8,5344	35	10,6680
07	2,1346	15	4,5720	22	6,7056	29	8,8392	36	10,9728
08	2,4384	16	4,8768	23	7,0104	30	9,1440	37	11,2776
09	2,7432	17	5,1816	24	7,3152	31	9,4488	38	11,5824
10	3,0480	18	5,4864	25	7,6200	32	9,7536	39	11,8872
11	3,3528	19	5,7912	26	7,9248	33	10,0584	40	12,1920
12	3,6576								

F06 CAVI OMC® - JOHNSON® - EVINRUDE® OMC® - JOHNSON® - EVINRUDE® CABLES



Cavo di comando tiro/spinta adatto ai motori Johnson, Evinrude e OMC di costruzione successiva al 1979. Terminale in acciaio inox. Parti metalliche in ottone trattato. Anima in acciaio inox da 2 mm. Terminale filettato 10-32 UNF.

Push/Pull control cable suitable for Johnson, Evinrude engines and OMC engines manufactured from 1979 to date. Stainless steel stock. Treated brass metallic parts. 2 mm stainless steel cup plug. Threaded terminal 10-32 UNF.

CARATTERISTICHE/ KEY FEATURES

Corsa / Stroke: 75 mm / 75 mm

Diametro guaina / Sheath diameter: 7 mm / 7 mm

Compatibilità / Suitable for: Utilizzabile su motori Johnson®, Evinrude®, OMC costruiti dal 1979 ad oggi.

For use with inboard, sterndrive and outboard engines, OMC® costruiti dal 1979 ad oggi.

CODICI ORDINAZIONE / ORDER CODES

62.00421.00

Indicare, al posto delle ultime due cifre, la lunghezza in piedi desiderata

To order the right cable replace the last two number (00) with the feet length required.

PIEDI FEET	METRI METER	PIEDI FEET	METRI METER	PIEDI FEET	METRI METER	PIEDI FEET	METRI METER	PIEDI FEET	METRI METER
05	1,5240	13	3,9624	20	6,0960	27	8,2296	34	10,3632
06	1,8288	14	4,2672	21	6,4008	28	8,5344	35	10,6680
07	2,1346	15	4,5720	22	6,7056	29	8,8392	36	10,9728
08	2,4384	16	4,8768	23	7,0104	30	9,1440	37	11,2776
09	2,7432	17	5,1816	24	7,3152	31	9,4488	38	11,5824
10	3,0480	18	5,4864	25	7,6200	32	9,7536	39	11,8872
11	3,3528	19	5,7912	26	7,9248	33	10,0584	40	12,1920
12	3,6576								

F14 CAVI OMC® - JOHNSON® - EVINRUDE® (SPECIFICO PER MOTORI COMANDO A BARRA) OMC® - JOHNSON® - EVINRUDE® CABLES (SPECIFIC FOR BAR CONTROL ENGINE)



Cavo di comando tiro/spinta adatto ai motori Johnson, Evinrude.
Terminale in acciaio inox.
Parti metalliche in ottone trattato.
Anima in acciaio inox da 2 mm.

Push/Pull control cable suitable for Johnson, Evinrude engines and OMC.
Stainless steel stock.
Treated brass metallic parts.
2 mm stainless steel cup plug.

CARATTERISTICHE/ KEY FEATURES

Corsa / Stroke:	75 mm / 75 mm
Diametro guaina / Sheath diameter:	7 mm / 7 mm
Compatibilità / Suitable for:	Utilizzabile su motori Johnson®, Evinrude®. For Johnson®, Evinrude

CODICI ORDINAZIONE / ORDER CODES

62.00004.03 lunghezza determinata per motori con comando a barra
Length determined for engines with control bar

PIEDI FEET	METRI METER
03	09140

Specifico per motori Johnson - Evinrude con comando a barra

Suitable for Johnson - Evinrude engines with control bar

S14 CAVO STOP STOP CABLE



Progettato per l'arresto dei motori entrobordo, può essere utilizzato anche per altre applicazioni (es. starter).

Designed for throttle fuel shut-off and other applications.

CARATTERISTICHE/ KEY FEATURES

Corsa / Stroke:	70 mm / 70 mm
Diametro guaina / Sheath diameter:	7 mm / 7 mm

CODICI ORDINAZIONE / ORDER CODES

62.00003.00 Indicare, al posto delle ultime due cifre, la lunghezza in piedi desiderata
To order the right cable replace the last two number (00) with the feet length required.

PIEDI FEET	METRI METER	PIEDI FEET	METRI METER	PIEDI FEET	METRI METER	PIEDI FEET	METRI METER
05	1,5240	14	4,2672	23	7,0104	32	9,7536
06	1,8288	15	4,5720	24	7,3152	33	10,0584
07	2,1346	16	4,8768	25	7,6200	34	10,3632
08	2,4384	17	5,1816	26	7,9248	35	10,6680
09	2,7432	18	5,4864	27	8,2296	36	10,9728
10	3,0480	19	5,7912	28	8,5344	37	11,2776
11	3,3528	20	6,0960	29	8,8392	38	11,5824
12	3,6576	21	6,4008	30	9,1440	39	11,8872
13	3,9624	22	6,7056	31	9,4488	40	12,1920



F07 CAVI MERCURY® - MERCUISER® - MARINER® MERCURY® - MERCUISER® - MARINER® CABLES



Cavo di comando tiro/spinta adatto ai motori Mercury e Mercruiser.
Terminale in acciaio inox.
Parti metalliche in ottone trattato.
Anima in acciaio inox da 2 mm.
Terminale filettato 10-32 UNF.

Push/Pull control cable suitable for Mercury and Mercruiser engines.
Stainless steel stok.
Treated brass metallic parts.
2 mm stainless steel cup plug.
Threaded terminal 10-32 UNF.

CARATTERISTICHE/ KEY FEATURES

Corsa / Stroke:	75 mm / 75 mm
Diametro guaina / Sheath diameter:	7 mm / 7 mm
Compatibilità / Suitable for:	Utilizzabile su motori Mercury®, Mercruiser® For Mercury®, Mercruiser® engines.

CODICI ORDINAZIONE / ORDER CODES

62.00431.00

Indicare, al posto delle ultime due cifre, la lunghezza in piedi desiderata
To order the right cable replace the last two number (00) with the feet length required.

PIEDI FEET	METRI METER	PIEDI FEET	METRI METER	PIEDI FEET	METRI METER	PIEDI FEET	METRI METER	PIEDI FEET	METRI METER
05	1,5240	13	3,9624	20	6,0960	27	8,2296	34	10,3632
06	1,8288	14	4,2672	21	6,4008	28	8,5344	35	10,6680
07	2,1346	15	4,5720	22	6,7056	29	8,8392	36	10,9728
08	2,4384	16	4,8768	23	7,0104	30	9,1440	37	11,2776
09	2,7432	17	5,1816	24	7,3152	31	9,4488	38	11,5824
10	3,0480	18	5,4864	25	7,6200	32	9,7536	39	11,8872
11	3,3528	19	5,7912	26	7,9248	33	10,0584	40	12,1920
12	3,6576								

F36 CAVI MERCURY® - MERCUISER® - MARINER® MERCURY® - MERCUISER® - MARINER® CABLES



Cavo di comando tiro/spinta adatto ai motori Mercury e Mercruiser.
Terminale in acciaio inox.
Parti metalliche in ottone trattato.
Anima in acciaio inox da 2 mm.

Push/Pull control cable for Mercury® and Mercruiser® engines and Mercury® Generation II™ series controls.
Stainless steel stok.
Treated brass metallic parts.
2 mm stainless steel cup plug.

CARATTERISTICHE/ KEY FEATURES

Corsa / Stroke:	85 mm / 85 mm
Diametro guaina / Sheath diameter:	7 mm / 7 mm
Compatibilità / Suitable for:	Utilizzabile su motori Mercury® e Mercruiser® e scatole di comando Mercury® serie Generation II™ For Mercury® and Mercruiser® engines and Mercury® Generation II™ series controls.

CODICI ORDINAZIONE / ORDER CODES

62.00759.00

Indicare, al posto delle ultime due cifre, la lunghezza in piedi desiderata
To order the right cable replace the last two number (00) with the feet length required.

PIEDI FEET	METRI METER	PIEDI FEET	METRI METER	PIEDI FEET	METRI METER	PIEDI FEET	METRI METER	PIEDI FEET	METRI METER
05	1,5240	13	3,9624	20	6,0960	27	8,2296	34	10,3632
06	1,8288	14	4,2672	21	6,4008	28	8,5344	35	10,6680
07	2,1346	15	4,5720	22	6,7056	29	8,8392	36	10,9728
08	2,4384	16	4,8768	23	7,0104	30	9,1440	37	11,2776
09	2,7432	17	5,1816	24	7,3152	31	9,4488	38	11,5824
10	3,0480	18	5,4864	25	7,6200	32	9,7536	39	11,8872
11	3,3528	19	5,7912	26	7,9248	33	10,0584	40	12,1920
12	3,6576								

F05 CAVI MERCURY® - MERCUISER® MERCURY® - MERCUISER® CABLES



Cavo di comando tiro/spinta adatto ai motori Mercury e Mercruiser.
Terminale in acciaio inox.
Parti metalliche in ottone trattato.
Anima in acciaio inox da 2 mm.

Push/Pull control cable suitable for Mercury and Mercruiser engines.
Stainless steel stok.
Treated brass metallic parts.
2 mm stainless steel cup plug.

CARATTERISTICHE/ KEY FEATURES

Corsa / Stroke:	95 mm / 95 mm
Diametro guaina / Sheath diameter:	7 mm / 7 mm
Compatibilità / Suitable for:	Utilizzabile su motori Mercury® e Mercruiser® e scatole di comando Mercury® serie Generation II™ <i>For Mercury® and Mercruiser® engines and Mercury® Generation II™ series controls.</i>

CODICI ORDINAZIONE / ORDER CODES

62.0002.00

lunghezza determinata per motori con comando a barra
Length determined for engines with control bar

PIEDI <i>FEET</i>	METRI <i>METER</i>	PIEDI <i>FEET</i>	METRI <i>METER</i>	PIEDI <i>FEET</i>	METRI <i>METER</i>	PIEDI <i>FEET</i>	METRI <i>METER</i>	PIEDI <i>FEET</i>	METRI <i>METER</i>
05	1,5240	13	3,9624	20	6,0960	27	8,2296	34	10,3632
06	1,8288	14	4,2672	21	6,4008	28	8,5344	35	10,6680
07	2,1346	15	4,5720	22	6,7056	29	8,8392	36	10,9728
08	2,4384	16	4,8768	23	7,0104	30	9,1440	37	11,2776
09	2,7432	17	5,1816	24	7,3152	31	9,4488	38	11,5824
10	3,0480	18	5,4864	25	7,6200	32	9,7536	39	11,8872
11	3,3528	19	5,7912	26	7,9248	33	10,0584	40	12,1920
12	3,6576								

F16 CAVI MARINER® MARINER® CABLES



Cavo di comando tiro/spinta adatto ai motori Mariner.
Terminale in acciaio inox.
Parti metalliche in ottone trattato.
Anima in acciaio inox da 2 mm.

Push/Pull control cable suitable for Mariner engines.
Stainless steel stok.
Treated brass metallic parts.
2 mm stainless steel cup plug.

CARATTERISTICHE/ KEY FEATURES

Corsa / Stroke:	80 mm / 80 mm
Diametro guaina / Sheath diameter:	7 mm / 7 mm
Compatibilità / Suitable for:	Utilizzabile su motori Mariner® con potenza fino a 40 HP <i>For Mariner® engines up to 40 HP</i>

CODICI ORDINAZIONE / ORDER CODES

62.00760.00

Indicare, al posto delle ultime due cifre, la lunghezza in piedi desiderata
To order the right cable replace the last two number (00) with the feet length required.

PIEDI <i>FEET</i>	METRI <i>METER</i>	PIEDI <i>FEET</i>	METRI <i>METER</i>	PIEDI <i>FEET</i>	METRI <i>METER</i>	PIEDI <i>FEET</i>	METRI <i>METER</i>	PIEDI <i>FEET</i>	METRI <i>METER</i>
05	1,5240	13	3,9624	20	6,0960	27	8,2296	34	10,3632
06	1,8288	14	4,2672	21	6,4008	28	8,5344	35	10,6680
07	2,1346	15	4,5720	22	6,7056	29	8,8392	36	10,9728
08	2,4384	16	4,8768	23	7,0104	30	9,1440	37	11,2776
09	2,7432	17	5,1816	24	7,3152	31	9,4488	38	11,5824
10	3,0480	18	5,4864	25	7,6200	32	9,7536	39	11,8872
11	3,3528	19	5,7912	26	7,9248	33	10,0584	40	12,1920
12	3,6576								



DESCRIZIONE / DESCRIPTION

Fermafilo con vite e copiglia
Wire-stop with screw and cotter pin

prezzo a conf. 10 PZ.
price per 10 pieces package



DESCRIZIONE / DESCRIPTION

Staffa per bloccocavo
Cable stop clamp

prezzo a conf. 5 PZ.
price per 5 pieces package



COD.ORDINAZIONE / ORDER COD.
62.00369.00

COD.ORDINAZIONE / ORDER COD.
62.00513.00

DESCRIZIONE / DESCRIPTION

Terminale per F02/F08
Cable head for F02/F08

prezzo a conf. 10 PZ.
price per 10 pieces package



DESCRIZIONE / DESCRIPTION

Fermafilo per F02-F08
Wire stop for F02/F08 cables

prezzo a conf. 10 PZ.
price per 10 pieces package



COD.ORDINAZIONE / ORDER COD.
62.00466.00

COD.ORDINAZIONE / ORDER COD.
62.00529.00

DESCRIZIONE / DESCRIPTION

Fermacavi
Stop cables

prezzo a conf. 10 PZ.
price per 10 pieces package



DESCRIZIONE / DESCRIPTION

Snodo filettato per cavi F02-F08
Ball threaded for F02/F08 cables

prezzo a conf. 5 PZ.
price per 5 pieces package



COD.ORDINAZIONE / ORDER COD.
62.00514.00

COD.ORDINAZIONE / ORDER COD.
62.00550.00

DESCRIZIONE / DESCRIPTION

Adattatore per montaggio
cavo universale su
monoleve Riviera
*Universal cable assembly
adapter for Riviera single
levers*



DESCRIZIONE / DESCRIPTION

Staffetta bloccaggio cavi
inox 316
*Cable stop clamp 316
stainless steel*

prezzo a conf. 10 PZ.
price per 10 pieces package



COD.ORDINAZIONE / ORDER COD.
62.00364.00

COD.ORDINAZIONE / ORDER COD.
62.00616.10 12x2,5x3,7mm
62.00370.00 12x2,1x3,2mm

DESCRIZIONE / DESCRIPTION

Forcella filettata per cavi F02-F08
Clevis for F02/F08 cables

prezzo a conf. 5 PZ.
price per 5 pieces package



COD.ORDINAZIONE / ORDER COD.
62.00546.00



DESCRIZIONE / DESCRIPTION

Selettore per invertitore e acceleratore per cavo F02 - F08
Inverter and accelerator selector for F02/F08 cables

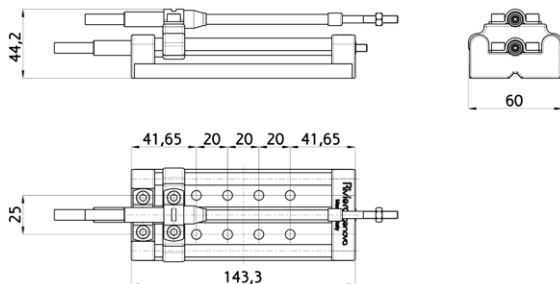

COD.ORDINAZIONE / ORDER COD.

62.00542.00

DESCRIZIONE / DESCRIPTION

Selettore per STOP per cavo S14
Stop selector for F14 cable

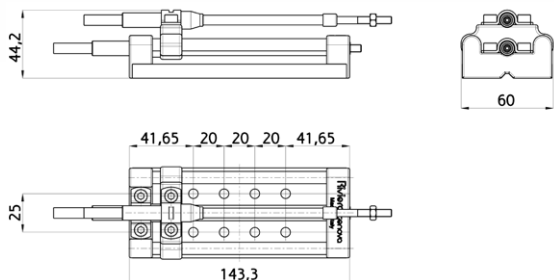

COD.ORDINAZIONE / ORDER COD.

62.00552.00



DESCRIZIONE / DESCRIPTION

Sicurezza motori TOHATSU
TOHATSU Engines safety



COD.ORDINAZIONE / ORDER COD.

62.00564.00 prezzo a conf. 10 PZ.
price per 10 pieces package

62.00557.00 Con laccio e moschettone
With lace and spring catch

DESCRIZIONE / DESCRIPTION

Sicurezza motori OMC
OMC Engines safety



COD.ORDINAZIONE / ORDER COD.

62.00566.00 prezzo a conf. 10 PZ.
price per 10 pieces package

62.00559.00 Con laccio e moschettone
With lace and spring catch

DESCRIZIONE / DESCRIPTION

Sicurezza motori YAMAHA
YAMAHA Engines safety



COD.ORDINAZIONE / ORDER COD.

62.00568.00 prezzo a conf. 10 PZ.
price per 10 pieces package

62.00561.00 Con laccio e moschettone
With lace and spring catch

DESCRIZIONE / DESCRIPTION

Sicurezza motori
MARINER - MERCURY
MARINER- MERCURY
Engines safety



COD.ORDINAZIONE / ORDER COD.

62.00570.00 prezzo a conf. 10 PZ.
price per 10 pieces package

62.00563.00 Con laccio e moschettone
With lace and spring catch

DESCRIZIONE / DESCRIPTION

KIT chiavette di sicurezza
per motori fuoribordo
Safety keys kit
for outboard engines

COD.ORDINAZIONE / ORDER COD.

62.00864.00 Con laccio e moschettone 7 chiavette
Security Stop 7 Keys with Coiled String

DESCRIZIONE / DESCRIPTION

Sicurezza motori
OMC - JOHNSON - EVINRUDE
OMC-JOHNSON-EVINRUDE
Engines safety



COD.ORDINAZIONE / ORDER COD.

62.00565.00 prezzo a conf. 10 PZ.
price per 10 pieces package

62.00558.00 Con laccio e moschettone
With lace and spring catch

DESCRIZIONE / DESCRIPTION

Sicurezza motori
OMC - HONDA
OMC-HONDA
Engines safety



COD.ORDINAZIONE / ORDER COD.

62.00567.00 prezzo a conf. 10 PZ.
price per 10 pieces package

62.00560.00 Con laccio e moschettone
With lace and spring catch

DESCRIZIONE / DESCRIPTION

Sicurezza motori
MARINER - SUZUKI
MARINER-SUZUKI
Engines safety



COD.ORDINAZIONE / ORDER COD.

62.00569.00 prezzo a conf. 10 PZ.
price per 10 pieces package

62.00562.00 Con laccio e moschettone
With lace and spring catch

DESCRIZIONE / DESCRIPTION

Moschettone
Spring catch



COD.ORDINAZIONE / ORDER COD.

62.00632.00 prezzo a conf. 10 PZ.
price per 10 pieces package



POMPETTE ADESCAMENTO / HAND PRIMER

Realizzate in materiale plastico di elevata qualità.
Elevato grado di elasticità. Temperatura di esercizio da -30 a +60 °C
High quality plastic material
Operating temperature range: -30°C to +60°C



COD.ORDINAZIONE / ORDER COD.

- 62.00450.00** Pompetta per tubo Ø 8 / Hand primer for hose Ø 8
- 62.00452.00** Pompetta per tubo Ø 8 + 2 m tubo / Hand primer for hose Ø 8 + 2 m length hose
- 62.00453.00** Pompetta per tubo Ø 8 + 3 m tubo / Hand primer for hose Ø 8 + 3 m length hose
- 62.00450.10** Pompetta per tubo Ø 8 in blister / Hand primer for hose Ø 8 - blister
- 62.00451.00** Pompetta per tubo Ø 9,5 / Hand primer for hose Ø 9,5
- 62.00454.00** Pompetta per tubo Ø 9,5 + 2 m tubo / Hand primer for hose Ø 9,5 + 2 m length hose
- 62.00455.00** Pompetta per tubo Ø 9,5 + 3 m tubo / Hand primer for hose Ø 9,5 + 3 m length hose
- 62.00451.10** Pompetta per tubo Ø 9,5 in blister / Hand primer for hose Ø 9,5 - blister

TUBO CARBURANTE / FUEL HOSE

DESCRIZIONE / DESCRIPTION

Bobina da 50 m. Tubo carburante d.8
50 m length. Fuel hose diam.8



COD.ORDINAZIONE / ORDER COD.

62.00725.00

DESCRIZIONE / DESCRIPTION

Tubo carburante certificato ISO 8469 B1
Fuel hose ISO 8469 B1

COD.ORDINAZIONE / ORDER COD.

- 62.00456.00** Ø 8 50m
- 62.00456.25** Ø 8 25m
- 62.00457.00** Ø 9,5 50m
- 62.00457.25** Ø 9,5 25m

Il tubo rispetta i requisiti della norma UNI EN ISO 8469 con resistenza superiore a 1.0 Mpa e mantenimento in soluzione di benzina RP e toluene RPE 55° - 85°.

The fuel hose has made following the classic requirements of the normative UNI EN ISO 8469 whit resistance bigger than 1.0 Mp and maintenance in petrol solution RP and toluene RPE 55° - 85°





JOHNSON EVINRUDE



Connettore maschio
Filetto in plastica
Lato serbatoio

*Male connection
Plastic thread
Tank side*

COD.ORDINAZIONE / ORDER COD. 62.00416.00
Quantità minima 5 Pz / *minimum quantity 5 pieces*



Connettore maschio
Innesto per tubo

*Male connection
Hose clutch*

COD.ORDINAZIONE / ORDER COD. 62.00417.00
Quantità minima 5 Pz / *minimum quantity 5 pieces*



Connettore femmina
Innesto per tubo

*Female connection
Hose clutch*

COD.ORDINAZIONE / ORDER COD. 62.00415.00
Quantità minima 5 Pz / *minimum quantity 5 pieces*

YAMAHA MERCURY MARINER



Connettore maschio corto
Filetto in plastica

*Male connection
Plastic thread*

COD.ORDINAZIONE / ORDER COD. 62.00410.00
Quantità minima 5 Pz / *minimum quantity 5 pieces*



Connettore maschio corto
Innesto per tubo

*Male connection
Hose clutch*

COD.ORDINAZIONE / ORDER COD. 62.00411.00
Quantità minima 5 Pz / *minimum quantity 5 pieces*



Connettore femmina
Innesto per tubo

*Female connection
Hose clutch*

COD.ORDINAZIONE / ORDER COD. 62.00409.00
Quantità minima 5 Pz / *minimum quantity 5 pieces*

MERCURY MARINER



Connettore maschio
Filetto in plastica
Lato serbatoio

*Male connection
Plastic thread
Tank side*

COD.ORDINAZIONE / ORDER COD. 62.00413.00
Quantità minima 5 Pz / *minimum quantity 5 pieces*



Connettore maschio
Innesto per tubo

*Male connection
Hose clutch*

COD.ORDINAZIONE / ORDER COD. 62.00414.00
Quantità minima 5 Pz / *minimum quantity 5 pieces*



Connettore femmina
Lato serbatoio

*Female connection
Tank side*

COD.ORDINAZIONE / ORDER COD. 62.00412.00
Quantità minima 5 Pz / *minimum quantity 5 pieces*

SELVA - TOHATSU NISSAN



Connettore maschio
Innesto per tubo
*Male connection
Hose clutch*

COD.ORDINAZIONE / ORDER COD. 62.00496.00
Quantità minima 5 Pz / *minimum quantity 5 pieces*



Connettore femmina
Female connection

COD.ORDINAZIONE / ORDER COD. 62.00495.00
Quantità minima 5 Pz / *minimum quantity 5 pieces*

HONDA



Connettore maschio
Filetto in plastica
Lato motore
*Male connection
Plastic thread
Engine side*

COD.ORDINAZIONE / ORDER COD. 62.00483.00
Quantità minima 5 Pz / *minimum quantity 5 pieces*



Connettore femmina
Lato serbatoio
*Female connection
Tank side*

COD.ORDINAZIONE / ORDER COD. 62.00482.00
Quantità minima 5 Pz / *minimum quantity 5 pieces*



Connettore femmina
innesto per tubo
*Female connection
Hose clutch*

COD.ORDINAZIONE / ORDER COD. 62.00486.00
Quantità minima 5 Pz / *minimum quantity 5 pieces*



Particolare innesto Honda
Particular of Honda graft



Particolare connettore femmina
Particular of female connector

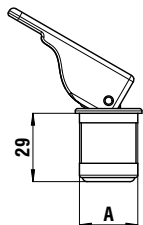

Particolare connettore maschio
Particular of male connector

**COD.ORDINAZIONE / ORDER COD.**

		A
62.00535.00	Aleggio espansione Nero <i>Black expansion plug</i>	25
62.00535.01	Aleggio espansione Bianco <i>White expansion plug</i>	25
62.00535.02	Aleggio espansione Grigio <i>Grey expansion plug</i>	25
62.00543.00	Aleggio espansione Nero <i>Black expansion plug</i>	35
62.00543.01	Aleggio espansione Bianco <i>White expansion plug</i>	35
62.00543.02	Aleggio espansione Grigio <i>Grey expansion plug</i>	35
62.00544.00	Aleggio espansione Nero <i>Black expansion plug</i>	40
62.00544.01	Aleggio espansione Bianco <i>White expansion plug</i>	40
62.00544.02	Aleggio espansione Grigio <i>Grey expansion plug</i>	40

prezzo a conf. 5 PZ. / price per 5 pieces package

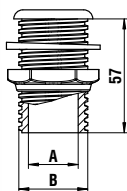
**COD.ORDINAZIONE / ORDER COD.**

		A	B
62.00536.00	Tubo + rondella Nero <i>Black drain fitting</i>	25	34
62.00536.01	Tubo + rondella Bianco <i>White drain fitting</i>	25	34
62.00572.00	Tubo + rondella Nero <i>Black drain fitting</i>	35	44
62.00572.01	Tubo + rondella Bianco <i>White drain fitting</i>	35	44
62.00573.00	Tubo + rondella Nero <i>Black drain fitting</i>	40	49
62.00573.01	Tubo + rondella Bianco <i>White drain fitting</i>	40	49

prezzo a conf. 5 PZ. / price per 5 pieces package

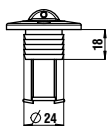
**COD.ORDINAZIONE / ORDER COD.**

62.00489.00	Aleggio tondo foro d.19 Nero <i>Round drain plug d.19 - black</i>
62.00489.01	Aleggio tondo foro d.19 Bianco <i>Round drain plug d.19 - white</i>

prezzo a conf. 10 PZ. / price per 10 pieces package

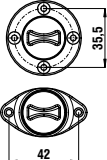
**COD.ORDINAZIONE / ORDER COD.**

62.00490.00	Aleggio ovale foro d.19 Nero <i>Oval shape drain plug d.19 - black</i>
62.00490.01	Aleggio ovale foro d.19 Bianco <i>Oval shape drain plug d.19 - white</i>

prezzo a conf. 10 PZ. / price per 10 pieces package

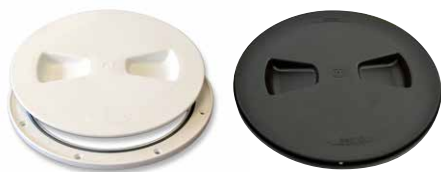

DESCRIZIONE / DESCRIPTION

Foro d'ispezione / Guarnizione stagna
 Materiale anti UV e antiolio
*Inspection hole / Sealing gasket
 Oil and UV resistant material*

COD.ORDINAZIONE / ORDER COD.

- 62.00491.00** Bianco Ø Int. 104 - Ø est. 140
White int. Ø 104 - est. Ø 140
- 62.00491.01** Nero Ø int. 104 - Ø est. 140
Black int. Ø 104 - est. Ø 140
- 62.00492.00** Bianco Ø int. 129 - Ø est. 165
White int. Ø 129 - est. Ø 165
- 62.00492.01** Nero Ø int. 129 - Ø est. 165
Black int. Ø 129 - est. Ø 165
- 62.00493.00** Bianco Ø int. 154 - Ø est. 190
White int. Ø 154 - est. Ø 190
- 62.00493.01** Nero Ø int. 154 - Ø est. 190
Black int. Ø 154 - est. Ø 190



DESCRIZIONE / DESCRIPTION

Moschettone / Prezzo a confezione 10 PZ.
Spring catch / price per 10 pieces package

COD.ORDINAZIONE / ORDER COD.

- 62.00521.00** Nero Ø foro per corda 8/9 mm
Black Ø hole for rope 8/9 mm
- 62.00521.01** Bianco Ø foro per corda 8/9 mm
White Ø hole for rope 8/9 mm
- 62.00520.00** Nero Ø foro per corda 6/7 mm
Black Ø hole for rope 6/7 mm
- 62.00520.01** Bianco Ø foro per corda 6/7 mm
White Ø hole for rope 6/7 mm
- 62.00519.00** Nero Ø foro per corda 4/5 mm
Black Ø hole for rope 4/5 mm
- 62.00519.01** Bianco Ø foro per corda 4/5 mm
White Ø hole for rope 4/5 mm
- 62.00518.00** Nero Ø foro per corda 2/3 mm
Black Ø hole for rope 2/3 mm
- 62.00518.01** Bianco Ø foro per corda 2/3 mm
White Ø hole for rope 2/3 mm



DESCRIZIONE / DESCRIPTION

Mezzo marinaio / Prezzo a confezione 10 PZ.
Boat hook / price per 10 pieces package

COD.ORDINAZIONE / ORDER COD.

- 62.00386.00** Ø 19
- 62.00385.00** Ø 27



DESCRIZIONE / DESCRIPTION

Redancia / Prezzo a confezione 10 PZ.
Himble / price per 10 pieces package

COD.ORDINAZIONE / ORDER COD.

- | | |
|--------------------------|--------------------------|
| 62.00388.01 mm 4 | 62.00388.08 mm 14 |
| 62.00388.02 mm 5 | 62.00388.09 mm 15 |
| 62.00388.03 mm 6 | 62.00388.10 mm 18 |
| 62.00388.04 mm 7 | 62.00388.11 mm 20 |
| 62.00388.05 mm 8 | 62.00388.12 mm 22 |
| 62.00388.06 mm 10 | 62.00388.13 mm 24 |
| 62.00388.07 mm 12 | |



DESCRIZIONE / DESCRIPTION

Gancio per gommone / Prezzo a confezione 10 PZ.
Rubber dinghy hook / price per 10 pieces package

COD.ORDINAZIONE / ORDER COD.

- 62.00516.00** Nero / Black
- 62.00516.01** Bianco / White



DESCRIZIONE / DESCRIPTION

Gancio da parete semichiuso / Prezzo a conf. 10 PZ.
Half closed wall hook / price per 10 pieces package

COD.ORDINAZIONE / ORDER COD.

- 62.00515.00** Nero / Black
- 62.00515.01** Bianco / White





DESCRIZIONE / DESCRIPTION

Molla d'ormeggio / *Spring Mooring*

COD.ORDINAZIONE / ORDER COD.

62.00768.00

Molla ormeggio **medio** mm 275x50x22

Diam. foro cima 12/14 - Carico di lavoro 250 Kg. per barche fino a 3 Ton.

Medium size spring mooring mm 275x50x22

Hole diameter rope 12/14 workload 250 Kg for boats up to 3 Tons.

62.00769.00

Molla ormeggio **grande** mm 320x55x25

Diam. foro cima 16/18 - Carico di lavoro 500 Kg. per barche fino a 8 Ton.

Big Size spring mooring mm 320x55x25

Hole diameter rope 16/18 workload 500 Kg for boats up to 8 Tons.



DESCRIZIONE / DESCRIPTION

Gancio da parete / Prezzo a confezione 10 PZ.

Wall hook / price per 10 pieces package

COD.ORDINAZIONE / ORDER COD.

62.00517.00 Nero / Black

62.00517.01 Bianco / White



DESCRIZIONE / DESCRIPTION

Galloccia / Prezzo a confezione 10 PZ.

Cleat / price per 10 pieces package

COD.ORDINAZIONE / ORDER COD.

62.00389.00 Lungh 110 / *Length 110*

62.00390.00 Lungh 165 / *Length 165*

62.00391.00 Lungh 220 / *Length 220*



DESCRIZIONE / DESCRIPTION

Supporti elastici / Prezzo a confezione 10 PZ. / *Spring clips / price per 10 pieces package*

COD.ORDINAZIONE / ORDER COD.

62.00528.00 Nero Ø 45 / Black Ø 45

62.00528.01 Bianco Ø 45 / White Ø 45

62.00527.00 Nero Ø 40 / Black Ø 40

62.00527.01 Bianco Ø 40 / White Ø 40

62.00526.00 Nero Ø 35 / Black Ø 35

62.00526.01 Bianco Ø 35 / White Ø 35

62.00525.00 Nero Ø 30 / Black Ø 30

62.00525.01 Bianco Ø 30 / White Ø 30

62.00524.00 Nero Ø 25 / Black Ø 25

62.00524.01 Bianco Ø 25 / White Ø 25

62.00523.00 Nero Ø 20 / Black Ø 20

62.00523.01 Bianco Ø 20 / White Ø 20

62.00522.00 Nero Ø 15 / Black Ø 15

62.00522.01 Bianco Ø 15 / White Ø 15



CE R2009

DESCRIZIONE / DESCRIPTION

Serbatoio verticale Eltex
Capacità 22 litri
Completo di indicatore di livello , pescante e tappo con sfiato
Riserva 2 litri
Dimensioni 405x330x240

*Eltex vertical tank
22 lt capacity
With fuel gauge, dip-tube and vent cap
2 lt reserve
Dimensions : 405x330x240*

COD.ORDINAZIONE / ORDER COD. 62.00467.00



CE R2010

DESCRIZIONE / DESCRIPTION

Serbatoio orizzontale Eltex
Capacità 12 litri
Completo di pescante e tappo con sfiato
Riserva 2 litri
Dimensioni 400x280x170

*Horizontal tank Eltex
12 lt capacity
With dip-tube and vent cap
2 lt reserve
Dimensions : 400x280x170*

COD.ORDINAZIONE / ORDER COD. 62.00468.00



CE R2011

DESCRIZIONE / DESCRIPTION

Serbatoio orizz. Eltex
Capacità 23 litri
Completo di indicatore di livello , pescante e tappo con sfiato
Riserva 3 litri
Dimensioni 460x340x230

*Eltex horizontal tank
23 lt capacity
With fuel gauge, dip-tube
and vent cap 3 lt reserve
Dimensions : 460x340x230*

COD.ORDINAZIONE / ORDER COD. 62.00469.00



CE R2012

DESCRIZIONE / DESCRIPTION

Serbatoio orizz. Eltex
Capacità 30 litri
Completo di indicatore di livello,pescante e tappo con sfiato
Riserva 3 litri
Conforme RINA

*Eltex horizontal tank
30 lt capacity
With fuel gauge, dip-tube
and vent cap 3 lt reserve
In conformity with RINA regulations
dimensions : 510x365x230*

COD.ORDINAZIONE / ORDER COD. 62.00470.00

RICAMBIO / REPLACEMENT

DESCRIZIONE / DESCRIPTION

Attacchi rapidi serbatoio / Quick connections for tank



COD.ORDINAZIONE / ORDER COD.

62.00782.00 (per R2009) / (for R2009)

62.00782.01 (per R2010) / (for R2010)

62.00782.02 (per R2011/2012) / (for R2011/2012)

ACCESSORIO OPZIONALE / OPTIONAL ACCESSORIES

DESCRIZIONE / DESCRIPTION

Tappo con sfiato e misuratore di livello
Cap with vent and level meter



COD.ORDINAZIONE / ORDER COD.

62.00783.00 (per R2010) / (for R2010)

62.00783.01 (per R2011/R2012) / (for R2011/R2012)





Riviera

**BUSSOLE MAGNETICHE
MAGNETIC COMPASSES**



MAGNETIC COMPASSES



BUSSOLE MAGNETICHE / MAGNETIC COMPASSES

		WHITE STAR									URANIA												
		B6W3	B6W4	B6W5	B6W6	BW1	BW2	BW3	BW4	BW5	BW6	BU1	BU2	BU3	BU4	BU5	BU6	BU7	BU8	BU9	BU10	BU11	
CERTIFICAZIONI CERTIFICATIONS	CERTIFICAZIONE MED MED CERTIFICATION	⊗	⊗	⊗		⊗	⊗	⊗	⊗			⊗	⊗	⊗	⊗	⊗	⊗						
	DEC. MIN. 388/99	•	•	•		•	•	•	•			•	•	•	•	•	•						
TIPO IMBARCAZIONE BOATS TYPE	RINA APPROVAL TIPO APPROVATO RINA	•	•	•		•	•	•	•			•	•	•	•	•	•						
	VELA / SAIL	•	•	•	•	•	•	•	•	•		•	•	•	•	•	•	•	•	•	•	•	•
	MOTORE / ENGINE	•	•	•	•	•	•	•	•	•		•	•	•	•	•	•	•	•	•	•	•	•
	GOMMONI INFLATTABLES DINGHYS																						
	LAVORO / FISHING VESSELS	•	•	•		•	•	•	•			•	•	•	•	•	•	•					
	SALVATAGGIO RESCUE BOATS	•	•	•		•	•	•	•			•	•	•	•	•	•	•					
MONTAGGIO MOUNT	INCASSO ORIZZONTALE HORIZ. FLUSH MOUNTED	•				•		•				•		•					•		•	•	
	INCASSO VERTICALE BULKHEAD MOUNTED																						
	CHIESUOLA / BINNACLE MOUNTED		•	•	•		•		•	•	•		•		•	•	•	•		•			
	STAFFA / BRACKET MOUNTED																						
	BAIONETTA BAYONET JOINT MOUNTED																						
	SUBACQUEA / SUB																						
	RILEVAMENTO HANDBEARING																						
ROSA CARD	DIAMETRO / DIAMETER	6"	6"	6"	6"	5"	5"	5"	5"	5"	5"	4"	4"	4"	4"	4"	4"	4"	4"	4"	4"	4"	
	GRADI / GRADUATION	5°2'	5°2'	5°2'	5°2'	5°2'	5°2'	5°2'	5°2'	5°2'	5°2'	5°2'	5°2'	5°2'	5°2'	5°2'	5°2'	5°	5°	5°	5°	5°	
	LETTURA FRONTALE DIRECT READING																				•	•	
	LETTURA POSTERIORE REAR READING	•	•	•	•	•	•	•	•	•	•	•	•	•	•	•	•	•	•	•			
	LINEA DI FEDE BIANCA WHITE LUBBER LINE					•	•			•		•	•										
	LINEA DI FEDE ROSSA RED LUBBER LINE	•	•	•	•		•	•		•		•	•		•	•	•	•	•	•	•	•	
ACCESSORI ACCESSORIES	ILLUMINAZIONE 24V DI SERIE (12V A RICH.) LIGHTING 24 V STANDARD (12V ON REQ.)	•	•	•	•	•	•	•	•	•													
	ILLUMINAZIONE 12V DI SERIE (24V A RICH.) LIGHTING 12V STANDARD (12V ON REQ.)										•	•	•	•	•	•	•						
	ILLUMINAZIONE 12V LIGHTING 12V																						
	ILLUMINAZIONE LED12-24 LIGHTING LED12-24																		•	•	•	•	
	COMPENSAZIONE INCORPORATA BUILT-IN COMPENSATION	•	•	•	•	•	•	•	•	•	•	•	•	•	•	•	•	•	•	•	•	•	
	CARDANICA INTERNA INTERNALLY GIMBALED	•	•	•	•	•	•	•	•	•	•	•	•	•	•	•	•	•	•	•	•	•	
	SEMI CARDANICA INTERNA INTERNALLY HALF GIMBALED																						
	A SPILLO JEWEL AND PIVOT MOVEMENTS																					•	•
	COPERTURA TELESCOPICA TELESCOPIC COVER			•						•	•								•	•	•	•	
	COPERTURA / COVER			•					•	•		•	•		•	•	•	•					



BUSSOLE MAGNETICHE

MAGNETIC COMPASSES

INSTALLAZIONE MOUNT	WHITE STAR 6"	WHITE STAR 5"	URANIA 4"	POLARE 3"4"	ASTRA 4"
CHIESUOLA BINNACLE MOUNT					
INCASSO ORIZZONTALE HORIZONTAL FLUSH MOUNTED					
A STAFFA BRACKET MOUNTED					
CHIESUOLA BINNACLE MOUNT					
INCASSO ORIZZONTALE HORIZONTAL FLUSH MOUNTED					 A soffitto Over head
INCASSO VERTICALE BULKHEAD MOUNTED					
A STAFFA BRACKET MOUNTED					
A BAIONETTA BAYONET JOINT MOUNTED					
RILEVAMENTO HANDBEARING	PRISMA 2"1/4			ORION 2"7/8	



ZENITH 3"	ARTICA 2"3/4	STELLA 2"1/2	ARIES 2"1/2	COMET 2"
				
				
				
				
				
				
				
<p>MIZAR2"7/8</p>				



DECRETO 29 Settembre 1999, n. 388 Regolamento recante norme per l'individuazione delle caratteristiche tecniche, i requisiti, le modalità per l'installazione a bordo delle bussole magnetiche, da utilizzare esclusivamente sulle unità da diporto.

**IL MINISTERO DEI TRASPORTI
E DELLA NAVIGAZIONE
ADOPTA**

il seguente regolamento:

Art. 1

Definizioni

1. Ai fini del presente regolamento si intende per:
- "Amministrazione": il Ministero dei trasporti e della navigazione
 - "unità da diporto": ogni costruzione destinata alla navigazione da diporto;
 - bussola magnetica: strumento per l'orientamento, atto a determinare la direzione del nord magnetico sfruttando l'azione del campo magnetico terrestre su un ago magnetico.

Art. 2

Campo di applicazione

1. Il presente regolamento si applica alla bussola magnetica a liquido e relativi accessori, destinati alle unità da diporto.

Art. 3

Requisiti

1. Le bussole magnetiche devono essere conformi al prototipo approvato dall'Amministrazione.
2. Possono essere utilizzate a bordo delle unità da diporto bussole magnetiche di tipo approvato per il diporto da uno degli Stati membri dell'Unione europea e dello Spazio economico europeo.

Art. 4

Caratteristiche

1. le bussole magnetiche a liquido da utilizzare sulle unità da diporto devono rispondere alle seguenti caratteristiche:
- essere costruite con materiali idonei all'uso in ambiente marino e di tipo amagnetico ad eccezione dei magneti che devono essere di idoneo materiale magnetico con elevata rimanenza coercitiva;
 - avere una linea di fede principale che indichi la direzione avanti della nave, di larghezza in corrispondenza della gradazione della rosa, non superiore all'ampiezza delle linee di divisione del quadrante e lunghezza tale da consentire la lettura quando il mortaio è inclinato di 10° nel caso di sospensione cardanica e di 30° negli altri casi;
 - nelle bussole di tipo non emisferico il mortaio deve avere sospensione cardanica con i due passi perpendicolari fra loro con tolleranza di + - 1°. I due assi inoltre devono trovarsi sullo stesso piano con le stesse tolleranze e quello esterno deve essere orientato secondo la direzione longitudinale della nave;
 - il liquido contenuto nel mortaio deve restare limpido, libero da bolle e non emulsionarsi ne gelare a temperature comprese fra -30°C e +60°C;
 - il mortaio non deve consentire perdite di liquido o infiltrazione d'aria;
 - i vetri o altri materiali trasparenti del mortaio devono avere idonei spessori e caratteristiche;
 - il momento di inerzia dell'equipaggiamento magnetico deve essere il più possibile uniforme rispetto ai tre assi principali passanti per il punto di sospensione e deve essere sufficientemente piccolo per consentire lo smorzamento rapido dell'oscillazione;
 - l'equipaggiamento magnetico deve essere mantenuto in posto con mezzi adeguati e restare libero quando il mortaio è inclinato di 10° in qualunque direzione o di 30° se la bussola non è cardanica;
 - l'equipaggiamento magnetico non deve subire danneggiamenti o deformazioni nel campo di temperature fra -30°C e +60°C;
 - la rosa deve essere dotata di stabilità statica, meccanica e magnetica, deve avere adeguata sensibilità, un diametro effettivo non minore di 100 millimetri (70 nelle emisferiche), essere graduata in uguali intervalli non maggiori di 5°, avere cifre, viste dall'alto, crescenti in senso orario partendo da nord, e consentire la lettura ad una distanza di un metro sia alla luce del giorno che

- a quella artificiale delle graduazioni comprese in un settore di almeno 15° da ciascun lato della linea di fede;
- m) l'errore di punteria (somma algebrica dell'errore di collimazione, di eccentricità e di graduazione) non deve superare 1,5°;
- n) se dotate di cerchio cardanico, l'errore d'indice, differenza tra linea di fede e il piano verticale passante per l'asse del cerchio cardanico esterno, non deve superare 1°;
- o) l'errore d'attrito o sensibilità scarto tra il valore primitivo e quello ottenuto dopo la deflessione di un piccolo angolo, non deve superare 1°;
- p) l'errore di trascinamento, differenza tra la lettura della prora dopo un giro completo del mortaio in un minuto e mezzo a velocità costante e quella effettuata a riposo, non deve superare 3,5° per rose di diametro inferiore a 200 millimetri;
- q) l'errore di induzione dovuto all'induzione magnetica trasmessa dagli aghi sistemati nell'equipaggiamento magnetico nei compensatori di ferro dolce (sfere o barre usate per correggere la deviazione quadrante) non deve essere superiore a 1°;
- r) il tempo che impiega la rosa per ritornare a meno di 1° dal meridiano magnetico a seguito di una deflessione iniziale della rosa stessa di 90° deve essere compreso tra 45 e 60 secondi per le bussole periodiche e inferiore ai 30 secondi per quelle aperiodiche quando la componente orizzontale terrestre è di 18 mt;
- s) il mortaio, lasciato libero dopo un'inclinazione di 5° rispetto al piano orizzontale, deve tornare alla posizione originale di riposo a meno di 1°;
- t) tutti i requisiti elencati devono essere soddisfatti alla temperatura di +20°C - 3°C.

Art. 5

Marcatura

1. Ogni bussola deve essere marcata in modo indelebile e leggibile con:
- nome e sede del fabbricante e dell'eventuale importatore;
 - nome o sigla del modello;
 - data di fabbricazione;
 - estremi dell'atto di approvazione del prototipo con dichiarazione di conformità al medesimo.

Art. 6

Sistemazione delle bussole a bordo

1. Il fabbricante deve corredare ogni bussola di adeguate istruzioni, anche in lingua italiana, per il suo montaggio, manutenzione ed uso.
2. Il cantiere costruttore dell'unità da diporto e il proprietario, in caso di modifiche successive, devono curare che la sistemazione a bordo della bussola sia fatta e conservata in modo da assicurarne il corretto funzionamento.

Art. 7

Compensazione - Verifiche

1. In occasione della prima installazione a bordo, le bussole magnetiche devono essere compensate da persone competenti autorizzate dall'Autorità marittima.
2. A compensazione avvenuta deve essere rilasciata la tabella delle deviazioni residue, tabella che, dopo essere stata controfirmata dall'Autorità marittima, deve essere conservata fra i documenti di bordo, unitariamente alle istruzioni di cui all'articolo 6.

Art. 8

Norma transitoria

1. Le bussole magnetiche installate su unità da diporto, costruite prima dell'entrata in vigore del presente regolamento, possono continuare ad essere utilizzate finché non se ne renda necessaria la sostituzione per cattivo stato di conservazione.

Il presente decreto, munito del sigillo dello Stato, sarà inserito nella Raccolta ufficiali e degli atti normativi della Repubblica Italiana. E' fatto obbligo a chiunque spetti di osservarlo e di farlo osservare.

Roma, 29 settembre 1999

il Ministro: Treu

Visto, il Guardasigilli: Diliberto
Registrato alla Corte dei conti il 20 ottobre 1999
Registro n. 2 Trasporti e navigazione, foglio n. 359

Decree of September 29, 1999, n. 388. Regulation and Standards regarding the rules about the technical features, the requirements, the regulation for the installation on board of magnetic compasses, to be used exclusively on the units' pleasure.

**THE MINISTRY OF TRANSPORT
AND NAVIGATION IS USE TO
adopt the following rules:**

**Art. n.1
Definitions:**

- 1.The purpose of this Regulation the following definitions:
- "Administration": the Ministry of Transport and Navigation
 - "Units' pleasure": any building intended for recreational boating
 - "magnetic compass": instrument for the orientation, able to determine the direction of the magnetic north thanks to the exploitation of the earth's magnetic field on a magnetic needle.

**Art. n. 2
Field Application**

- 1.The present Regulation is applicable to the magnetic compass liquid and to the relative accessories as well, for the units' pleasure.

**Art. n. 3
Requirements**

The magnetic compasses have to be conformed to the prototype that is approved from the Administration. Can be utilised on board of unit's pleasure magnetic compasses of kind approved for the pleasure from a member state of the European Union and of the European Economic Area as well.

**Art. n. 4
Features**

- 1.The magnetic liquid compasses to use on units' pleasure must correspond to the following features:
- They must be realised with suitable material for use in a marine environment and of magnetic type, with the exception of the magnets which must be of suitable magnetic material with high remanence coercivity.
 - They have to have a lubber line main able to indicate the front direction of the ship, they have to have a width in correspondence with the gradation of the card, not bigger than the size of the dividing lines of the quadrant and they must have a length able to allow the reading when the mortar is inclined of 10° in case of gimbal suspension and of 30° in the others cases.
 - In the compasses of not hemispherical kind the mortar must have gimbal suspension with the 2 axes perpendicular to each other with a tolerance of + - 1°. Also the 2 axes have to be exactly at the same level with the same tolerances and the axis outer must to be oriented considering the longitudinal direction of the boat.
 - The liquid inside the mortar must remain limpid, free of bubbles and it must not emulsify and it must not freeze with temperatures including between -30° and +60°.
 - The mortar must not allow losses of liquid or air infiltration as well.
 - The glasses or even other transparent materials of the mortar must have suitable features and suitable thickness.
 - The magnetic moment of inertia of the magnetic equipment must be the most possible uniform compared to the 3 principal axes through the suspension point and it has to be enough small to allow the fast damping of the oscillation.
 - The magnetic equipment must be maintained in a place with appropriate means and it has to remain free when the mortar is inclined of 10° in any direction or of 30° if the compass is not gimbal.
 - The magnetic equipment must not be damaged or deformations in the temperature range between 30°C e + 60°C
 - The card has to be equipped of established static, mechanics and magnetic, it must have adequate sensitivity, an effective diameter not smaller than 100 millimeter, (70 millimeter in the ones hemispherical).

Also the card must to be graduated in same intervals not bigger than 5°, and it must have numbers, seen from above, increasing clockwise starting from the North and it also must allow a reading at a distance of 1 meter with the natural sunlight and with the one artificial of the graduations including in a sector of at least 15° from any side of lubber line.

- The mistake of taper, (algebraic sum of the mistake of collimation of eccentricity and graduation) must not exceed 1,5°.
- If equipped with cardan wheel, the index mistake, (the different between the lubber line and the vertical plane (zone) passing through the outer gimbal circle
- The mistake of friction or sensitivity waste from the primitive value and the one obtained after the deflection of a small angle, must not be bigger than 1°
- The dragging mistake, (the difference from the reading of bow after a full circle of mortar in a 1 and ½ minute with speed constant and the one performed in rest conditions), must not be bigger than 3,5°, for card with diameter less than 200 mm.
- The induction mistake due to magnetic induction transmitted by the needles that are located in the magnetic equipment in compensators of soft iron, (spheres or bares used to correct the quadrantal deviation) must not to be bigger than 1°.
- The time necessary for the card to return to less than 1° from the magnetic meridian following a initial deflection of the rose of 90°, must be including between 45 and 60 seconds for the periodic compasses and it must be less than 30° for the aperiodic compasses when the horizontal terrestrial component is of 18
- The mortar, left after a swing of 5° with the respect of the horizontal plane, must return to the original resting position -1°

**Art. n. 5
Marking**

- 1.Compass must be marked in an indelible way and it must be readable with:
- name and location of the producer and also with the details of the importer
 - name or abbreviation of the model
 - date of manufacture
 - extremes of approval of the prototype with the declaration of conformity to the same

Art. n. 6

- Accommodation of the compasses on board
- The producer must accompany any compass with the adequate instructions, also in Italian Language, (regarding the mounting, maintenance and use of the compass)
 - The yard builder of the unit's pleasure and the owner, in case of subsequent changes, must take care the accommodation on board of the compass to ensure the proper functioning.

**Art. n. 7
Compensation and checks**

With the occasion of the first installation on board, the magnetic compasses must be compensated from competent people and authorized from the Maritime Authority. When the compensation is done, it is relevant to have the table of the residual deviations, table that, after being countersigned from the Maritime Authority, must to be preserved with the board documents exactly like the instructions of the Art.n.6

**Art. n. 8
Transitional Rule**

- 1.The magnetic compasses installed on units' pleasure, realized before the entry into force of this Rules, may continue to be used until the moment will be necessary replacement for bad state of conservation. This Decree, bearing the sale of the State, will be included in the official collection and in the Legislation of the Italian Republic. All those who have the obligation to observe it must do it.

Rome, September 29, 1999

The Minister: Treu

By, the Kepeer:Diliberto
Registered at Earls Court 20 October 1999
Register n. 2, Transport ad Navigation, document n. 359



Riviera

BUSSOLE MAGNETICHE
MAGNETIC COMPASSES

COMPASSES - WHITE STAR 6" & 5"



WHITE STAR 6" & 5"



WHITE STAR 6"

WHITE STAR 5"

Bussola magnetica installazione a chiesuola

Binnacle mounted magnetic compass

B6W6

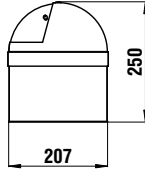

BW6

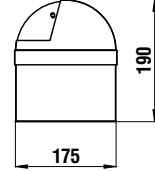

B6W5

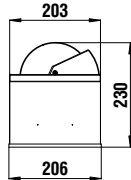

BW5

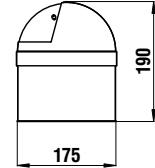

B6W4

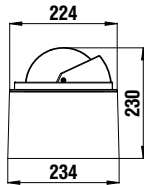

BW4

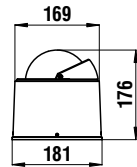

BW2

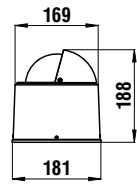

Bussola magnetica installazione a incasso orizzontale

Horizontal flush mounted magnetic compass

B6W3

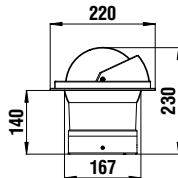

BW3

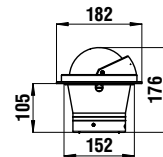

BW1

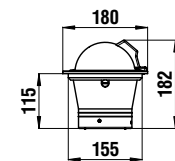

105 COMPASSES - WHITE STAR 6" & 5"



WHITE STAR 6"

CARATTERISTICHE GENERALI / STANDARD FEATURES

Diametro apparente: 6" - 150 mm

Lettura: Posteriore

Sospensione: Cardanica Interna

Rosa: Nera 5° - 2°

Illuminazione 24V (12V su richiesta)

Per imbarcazioni ad alta velocità/normali

Compensazione incorporata

Schermo antiriflesso

100% Riparabile

Garanzia 3 anni

Fabbricata 100% in Italia

Certificazione MED su richiesta

Apparent card diameter: 6" - 150 mm

Reading: Rear

Gymbal type: Internally gimbaled

Card: Black 5° - 2°

Lighting 24V (12V on request)

For high speed boats/standard

Built-in compensation setting

Anti-glare screen

100% Repairable

Warranty 3 anni/years

Handcrafted 100% in Italy

MED certification on request



OMOLOGAZIONI E CERTIFICATI / HOMOLOGATIONS AND CERTIFICATES

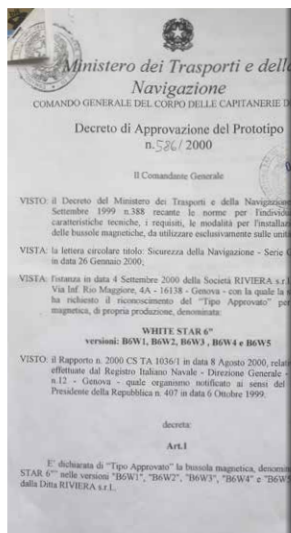

COMPASSES - WHITE STAR 6"

1

In base al Decreto Ministeriale del 27 settembre 1999 n. 388 per strumentazione di sicurezza per barche da diporto fuori dalle 6 miglia, Riviera ha avuto l'approvazione con il Decreto Ministeriale di approvazione del prototipo 586/2000 per bussole White Star 6".

Under ministerial decree (Decree for safety equipment for boats out six miles Riviera has been approved by Ministry of Transport and Navigation for compasses White Star 6" with DAP 586/2000.

2

Su richiesta On request

Certificato MED in accordo con la direttiva MED 2014/90/EU riguardo alle imbarcazioni di salvataggio e battelli di emergenza.

MED Certification

According to the directive MED 2014/90/EU, regarding lifeboats and rescue boats

3

Su richiesta On request

Certificazione tipo approvato RINA per imbarcazioni da pesca e da lavoro inferiori a 150 GT.

RINA type approval certificate for merchant ships and fishing vessels of less than 150 GT

WHITE STAR 6"

Riviera **B6W6**



Linea di fede rossa
Red Lubber line

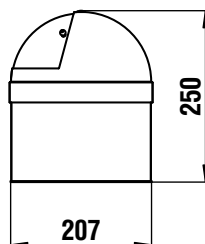

Rosa 2° *Card graduations 2°*



Rosa 5° *Card graduations 5°*

Inox/*Stainless*

Colori bussola / *compass colors*

B6W6 installazione a chiesuola / *Binnacle mounted*

CARATTERISTICHE / *KEY FEATURES*

Sospensione: Cardanica interna	<i>Gimbal type: Internally gimbaled</i>
Illuminazione: 24V di serie (12V a richiesta)	<i>Lighting: 24V standard (12V on request)</i>
Letture: Posteriore - linea di fede rossa	<i>Reading: Rear - red lubber line</i>
Divisione rosa: 5° - 2°	<i>Card graduations: 5° - 2°</i>
Diametro apparente: 6" - 150 mm	<i>Apparent card dia: 6" - 150 mm</i>
Per imbarcazioni ad alta velocità / normali	<i>For high speed boats / standard</i>
Compensazione incorporata	<i>Built-in compensation setting</i>
Coperchio di protezione inox	<i>Stainless steel cover</i>
100% Riparabile	<i>100% Repairable</i>
Garanzia 3 anni	<i>Warranty 3 years</i>
Fabbricata 100% in Italia	<i>Handcrafted 100% in Italy</i>
Certificazione MED su richiesta	<i>MED certification on request</i>

CODICI ORDINAZIONE / *ORDER CODES*

- 62.00133.01** Inox 5° Rosa nera / *Stainless steel 5° Black card*
- 62.00134.01** Inox 2° Rosa nera / *Stainless steel 2° Black card*

Accessori
Accessories



Coperchio di protezione inox

Protective cover stainless steel

62.00154.01



WHITE STAR 6"

Riviera **B6W5**

Su richiesta / *On request*



DM 586/200
incluso / *included.*



Linea di fede rossa
Red Lubber line

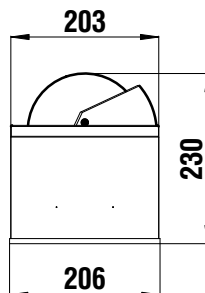

Rosa 2° *Card graduations 2°*



Rosa 5° *Card graduations 5°*

Bianca/*White*

Colori bussola / *compass colors*

B6W5 installazione a chiesuola / *Binnacle mounted*

CARATTERISTICHE / *KEY FEATURES*

Sospensione: Cardanica interna	<i>Gimbal type: Internally gimbale</i>
Illuminazione: 24V di serie (12V a richiesta)	<i>Lighting: 24V standard (12V on request)</i>
Letture: Posteriore - linea di fede rossa	<i>Reading: Rear - red lubber line</i>
Divisione rosa: 5° - 2°	<i>Card graduations: 5° - 2°</i>
Diametro apparente: 6" - 150 mm	<i>Apparent card dia: 6" - 150 mm</i>
Per imbarcazioni ad alta velocità / normali	<i>For high speed boats / standard</i>
Compensazione incorporata	<i>Built-in compensation setting</i>
Schermo antiriflesso	<i>Anti-glare screen</i>
100% Riparabile	<i>100% Repairable</i>
Garanzia 3 anni	<i>Warranty 3 years</i>
Fabbricata 100% in Italia	<i>Handcrafted 100% in Italy</i>
Certificazione MED su richiesta	<i>MED certification on request</i>

CODICI ORDINAZIONE / *ORDER CODES*

62.00107.01 Bianca 5° Rosa nera / *White 5° Black card*
62.00108.01 Bianca 2° Rosa nera / *White 2° Black card*

Accessori
Accessories



Coperchio di
protezione bianco

*Protective cover
white*

62.00104.01

COMPASSES - WHITE STAR 6"

Riviera **WHITE STAR 6"** **B6W4**

Su richiesta / *On request*



DM 586/200
incluso / *included.*



Linea di fede rossa
Red Lubber line

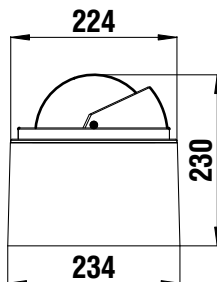

Rosa 2° *Card graduations 2°*



Rosa 5° *Card graduations 5°*

Nera/*Black*

Colori bussola / *compass colors*

B6W4 installazione a chiesuola / *Binnacle mounted*

CARATTERISTICHE / *KEY FEATURES*

Sospensione: Cardanica interna	<i>Gimbal type: Internally gimbaled</i>
Illuminazione: 24V di serie (12V a richiesta)	<i>Lighting: 24V standard (12V on request)</i>
Letture: Posteriore - linea di fede rossa	<i>Reading: Rear - red lubber line</i>
Divisione rosa: 5° - 2°	<i>Card graduations: 5° - 2°</i>
Diametro apparente: 6" - 150 mm	<i>Apparent card dia: 6" - 150 mm</i>
Per imbarcazioni ad alta velocità / normali	<i>For high speed boats / standard</i>
Compensazione incorporata	<i>Built-in compensation setting</i>
Schermo antiriflesso	<i>Anti-glare screen</i>
100% Riparabile	<i>100% Repairable</i>
Garanzia 3 anni	<i>Warranty 3 years</i>
Fabbricata 100% in Italia	<i>Handcrafted 100% in Italy</i>
Certificazione MED su richiesta	<i>MED certification on request</i>

CODICI ORDINAZIONE / *ORDER CODES*

- 62.00102.01 Nera 5° Rosa nera - Alta velocità / *Black 5° Black card - high speed*
- 62.00101.01 Nera 2° Rosa nera - Alta velocità / *Black 2° Black card - high speed*
- 62.00080.01 Nera 5° Rosa nera / *Black 5° Black card*
- 62.00079.01 Nera 2° Rosa nera / *Black 2° Black card*



WHITE STAR 6"

Riviera **B6W3**

Su richiesta / *On request*



DM 586/200
incluso / *included.*



Linea di fede rossa
Red Lubber line

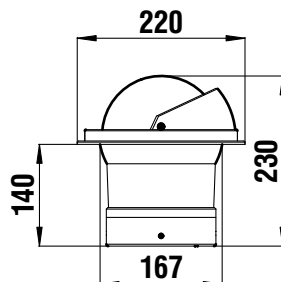

Rosa 2° *Card graduations 2°*



Rosa 5° *Card graduations 5°*

Nera/*Black*

Colori bussola / *compass colors*

B6W3 installazione ad incasso orizzontale / *Horizontal flush mounted*

CARATTERISTICHE / *KEY FEATURES*

Sospensione: Cardanica interna	<i>Gimbal type: Internally gimballed</i>
Illuminazione: 24V di serie (12V a richiesta)	<i>Lighting: 24V standard (12V on request)</i>
Lettura: Posteriore - linea di fede rossa	<i>Reading: Rear - red lubber line</i>
Divisione rosa: 5° - 2°	<i>Card graduations: 5° - 2°</i>
Diametro apparente: 6" - 150 mm	<i>Apparent card dia: 6" - 150 mm</i>
Per imbarcazioni ad alta velocità / normali	<i>For high speed boats / standard</i>
Compensazione incorporata	<i>Built-in compensation setting</i>
Schermo antiriflesso	<i>Anti-glare screen</i>
100% Riparabile	<i>100% Repairable</i>
Garanzia 3 anni	<i>Warranty 3 years</i>
Fabbricata 100% in Italia	<i>Handcrafted 100% in Italy</i>
Certificazione MED su richiesta	<i>MED certification on request</i>

CODICI ORDINAZIONE / *ORDER CODES*

- 62.00100.01** Nera 5° Rosa nera - Alta velocità / *Black 5° Black card - high speed*
- 62.00099.01** Nera 2° Rosa nera - Alta velocità / *Black 2° Black card - high speed*
- 62.00078.01** Nera 5° Rosa nera / *Black 5° Black card*
- 62.00077.01** Nera 2° Rosa nera / *Black 2° Black card*

WHITE STAR 5"



CARATTERISTICHE GENERALI / STANDARD FEATURES

Diametro apparente: 5" - 130 mm
 Lettura : Posteriore
 Sospensione : Cardanica Interna
 Rosa: Nera-Rossa 5° - 2°
 Illuminazione 24V (12V su richiesta)
 Per imbarcazioni ad alta velocità/normali
 Compensazione incorporata
 Schermo antiriflesso
 100% Riparabile
 Garanzia 3 anni
 Fabbricata 100% in Italia
 Certificazione MED su richiesta

Apparent card diameter: 5" - 130 mm
 Reading : Rear
 Gymbal type: Internally gimballed
 Card: Black - Red 5° - 2°
 Lighting 24V (12V on request)
 For high speed boats/standard
 Built-in compensation setting
 Anti-glare screen
 100% Repairable
 Warranty 3 years
 Handcrafted 100% in Italy
 MED certification on request



OMOLOGAZIONI E CERTIFICATI / HOMOLOGATIONS AND CERTIFICATES

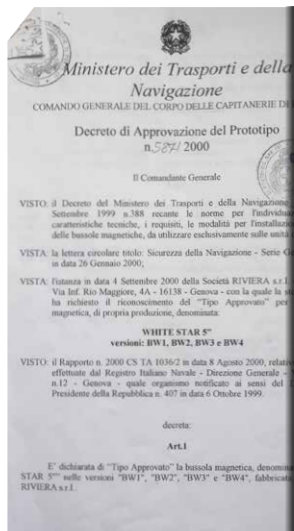

1

In base al Decreto Ministeriale del 29 settembre 1999 n. 388 per strumentazione di sicurezza per barche da diporto fuori dalle 6 miglia, Riviera ha avuto l'approvazione con il Decreto Ministeriale di approvazione del prototipo 587/2000 per bussole White Star 5".

Under ministerial decree (Decree for safety equipment for boats out six miles Riviera has been approved by Ministry of Transport and Navigation for compasses White Star 5" with DAP 587/2000.

2

Su richiesta *On request*

Certificato MED in accordo con la direttiva MED 2014/90/EU riguardo alle imbarcazioni di salvataggio e battelli di emergenza.

MED Certification
 According to the directive MED 2014/90/EU, regarding lifeboats and rescue boats

3

Su richiesta *On request*

Certificazione tipo approvato RINA per imbarcazioni da pesca e da lavoro inferiori a 150 GT.

RINA type approval certificate for merchant ships and fishing vessels of less than 150 GT

111 COMPASSES - WHITE STAR 5"



Riviera

WHITE STAR 5"

BW6

Le bussole BW6 sono dotate di coperchio di protezione inox

The BW6 compasses have the stainless steel cover included



Linea di fede rossa
Red Lubber line

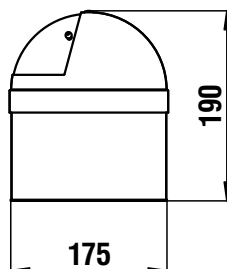

Rosa 2° *Card graduations 2°*



Rosa 5° *Card graduations 5°*

Inox/*Stainless*

Colori bussola / *compass colors*

BW6 installazione a chiesuola / *Binnacle mounted*

CARATTERISTICHE / *KEY FEATURES*

Sospensione: Cardanica interna

Gimbal type: Internally gimbale

Illuminazione: 24V di serie (12V a richiesta)

Lighting: 24V standard (12V on request)

Letture: Posteriore - linea di fede rossa

Reading: Rear - red lubber line

Divisione rosa: 5° - 2°

Card graduations: 5° - 2°

Diametro apparente: 5" - 130 mm

Apparent card dia: 5" - 130 mm

Per imbarcazioni ad alta velocità / normali

For high speed boats / standard

Compensazione incorporata

Built-in compensation setting

Coperchio di protezione inox

Stainless steel cover

100% Riparabile

100% Repairable

Garanzia 3 anni

Warranty 3 years

Fabbricata 100% in Italia

Handcrafted 100% in Italy

Certificazione MED su richiesta

MED certification on request

CODICI ORDINAZIONE / *ORDER CODES*

62.00132.01 Inox 5° Rosa nera - Alta velocità / *SST 5° Black card - high speed*

62.00138.01 Inox 2° Rosa nera - Alta velocità / *SST 2° Black card - high speed*

62.00131.01 Inox 5° Rosa nera / *Stainless steel 5° Black card*

62.00139.01 Inox 2° Rosa nera / *Stainless steel 2° Black card*

Accessori
Accessories



Coperchio di protezione inox

Protective cover stainless steel

62.00155.01

COMPASSES - WHITE STAR 5"

Riviera **WHITE STAR 5"** **BW5**

Le bussole BW5 sono dotate di coperchio di protezione inox

The BW5 compasses have the stainless steel cover included



Linea di fede bianca
White lubber line

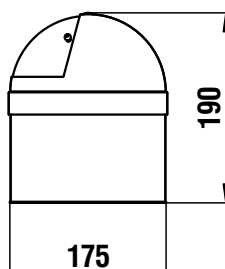

Rosa 2° *Card graduations 2°*



Rosa 5° *Card graduations 5°*

Inox/*Stainless*

Colori bussola / *compass colors*

BW5 installazione a chiesuola / Binnacle mounted

CARATTERISTICHE / KEY FEATURES

Sospensione: Cardanica interna	<i>Gimbal type: Internally gimbalead</i>
Illuminazione: 24V di serie (12V a richiesta)	<i>Lighting: 24V standard (12V on request)</i>
Letture: Posteriore - linea di fede bianca	<i>Reading: Rear - white lubber line</i>
Divisione bianca: 5° - 2°	<i>Card graduations: 5° - 2°</i>
Diametro apparente: 5" - 130 mm	<i>Apparent card dia: 5" - 130 mm</i>
Per imbarcazioni ad alta velocità / normali	<i>For high speed boats / standard</i>
Compensazione incorporata	<i>Built-in compensation setting</i>
Coperchio di protezione inox	<i>Stainless steel cover</i>
100% Riparabile	<i>100% Repairable</i>
Garanzia 3 anni	<i>Warranty 3 years</i>
Fabbricata 100% in Italia	<i>Handcrafted 100% in Italy</i>
Certificazione MED su richiesta	<i>MED certification on request</i>

CODICI ORDINAZIONE / ORDER CODES

- 62.00130.01** Inox 5° Rosa nera - Alta velocità / *SST 5° Black card - high speed*
- 62.00136.01** Inox 2° Rosa nera - Alta velocità / *SST 2° Black card - high speed*
- 62.00129.01** Inox 5° Rosa nera / *Stainless steel 5° Black card*
- 62.00137.01** Inox 2° Rosa nera / *Stainless steel 2° Black card*

Accessori
Accessories



Coperchio di protezione inox

Protective cover stainless steel

62.00155.01

COMPASSES - WHITE STAR 5"



WHITE STAR 5"

Riviera **BW4**

Su richiesta / *On request*



DM 587/200
incluso / *included.*



Linea di fede rossa
Red Lubber line

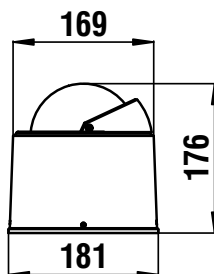

Rosa 5° *Card graduations 5°*



Rosa 2° *Card graduations 2°*

Nera/*Black*

Colori bussola / *compass colors*

BW4 installazione a chiesuola / *Binnacle mounted*

CARATTERISTICHE / *KEY FEATURES*

Sospensione: Cardanica interna	<i>Gimbal type: Internally gimbale</i>
Illuminazione: 24V di serie (12V a richiesta)	<i>Lighting: 24V standard (12V on request)</i>
Letture: Posteriore - linea di fede rossa	<i>Reading: Rear - red lubber line</i>
Divisione rosa: 5° - 2°	<i>Card graduations: 5° - 2°</i>
Diametro apparente: 5" - 130 mm	<i>Apparent card dia: 5" - 130 mm</i>
Per imbarcazioni ad alta velocità / normali	<i>For high speed boats / standard</i>
Compensazione incorporata	<i>Built-in compensation setting</i>
Schermo antiriflesso	<i>Anti-glare screen</i>
100% Riparabile	<i>100% Repairable</i>
Garanzia 3 anni	<i>Warranty 3 years</i>
Fabbricata 100% in Italia	<i>Handcrafted 100% in Italy</i>
Certificazione MED su richiesta	<i>MED certification on request</i>

CODICI ORDINAZIONE / *ORDER CODES*

- 62.00056.01 Nera 5° Rosa nera Alta velocità / *Black 5° Black card - high speed*
- 62.00056.10 Nera 5° Rosa rossa Alta velocità / *Black 5° Red card - high speed*
- 62.00140.01 Nera 2° Rosa nera Alta velocità / *Black 2° Black card - high speed*
- 62.00055.01 Nera 5° Rosa nera / *Black 5° Black card*
- 62.00054.01 Nera 2° Rosa nera / *Black 2° Black card*
- 62.00113.01 Bianca 5° Rosa nera / *White 5° Black card*
- 62.00141.01 Bianca 2° Rosa nera / *White 2° Black card*

Accessori
Accessories



Coperchio di protezione bianco
Protective cover white

62.00180.01 Bianco / *White*



Coperchio di protezione bianco
Protective cover white

62.00117.01 Bianco / *White*



Calotta di protezione in tela
Protective cover Canvas hood

62.00062.01

COMPASSES - WHITE STAR 5"

WHITE STAR 5" BW2

Riviera

Su richiesta / On request



DM 587/200
incluso / included.



Linea di fede bianca
White lubber line

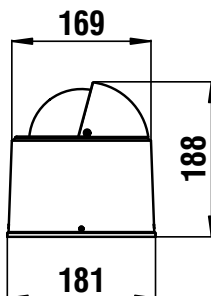

Rosa 5° Card graduations 5°



Rosa 2° Card graduations 2°

Nera/Black

Colori bussola / compass colors

BW2 installazione a chiesuola / Binnacle mounted

CARATTERISTICHE / KEY FEATURES

Sospensione: Cardanica interna	<i>Gimbal type: Internally gimbalead</i>
Illuminazione: 24V di serie (12V a richiesta)	<i>Lighting: 24V standard (12V on request)</i>
Letture: Posteriore - linea di fede bianca	<i>Reading: Rear - white lubber line</i>
Divisione rosa: 5° - 2°	<i>Card graduations: 5° - 2°</i>
Diametro apparente: 5" - 130 mm	<i>Apparent card dia: 5" - 130 mm</i>
Per imbarcazioni ad alta velocità / normali	<i>For high speed boats / standard</i>
Compensazione incorporata	<i>Built-in compensation setting</i>
Schermo antiriflesso	<i>Anti-glare screen</i>
100% Riparabile	<i>100% Repairable</i>
Garanzia 3 anni	<i>Warranty 3 years</i>
Fabbricata 100% in Italia	<i>Handcrafted 100% in Italy</i>
Certificazione MED su richiesta	<i>MED certification on request</i>

CODICI ORDINAZIONE / ORDER CODES

- 62.00021.01 Nera 5° Rosa nera Alta velocità / *Black 5° Black card - high speed*
- 62.00021.10 Nera 5° Rosa rossa - Alta velocità / *Black 5° Red card - high speed*
- 62.00023.01 Nera 2° Rosa nera Alta velocità / *Black 2° Black card - high speed*
- 62.00025.01 Nera 5° Rosa nera / *Black 5° Black card*
- 62.00027.01 Nera 2° Rosa nera / *Black 2° Black card*

Accessori
Accessories



Coperchio di protezione bianco
Protective cover white

62.00117.01 Bianco / *White*



Calotta di protezione in tela
Protective cover Canvas hood

62.00062.01

115 COMPASSES - WHITE STAR 5"



WHITE STAR 5"

Riviera **BW3**

Su richiesta / *On request*



DM 587/200
incluso / *included.*



Linea di fede rossa
Red Lubber line

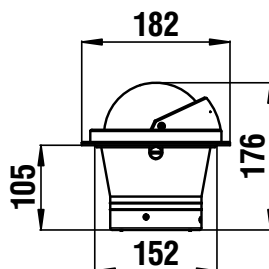

Rosa 5° *Card graduations 5°*



Rosa 2° *Card graduations 2°*

Nera/*Black*

Colori bussola / *compass colors*

BW3 installazione ad incasso orizzontale / *Horizontal flush mounted*

CARATTERISTICHE / *KEY FEATURES*

Sospensione: Cardanica interna	<i>Gimbal type: Internally gimbale</i>
Illuminazione: 24V di serie (12V a richiesta)	<i>Lighting: 24V standard (12V on request)</i>
Lettura: Posteriore - linea di fede rossa	<i>Reading: Rear - red lubber line</i>
Divisione rosa: 5° - 2°	<i>Card graduations: 5° - 2°</i>
Diametro apparente: 5" - 130 mm	<i>Apparent card dia: 5" - 130 mm</i>
Per imbarcazioni ad alta velocità / normali	<i>For high speed boats / standard</i>
Compensazione incorporata	<i>Built-in compensation setting</i>
Schermo antiriflesso	<i>Anti-glare screen</i>
100% Riparabile	<i>100% Repairable</i>
Garanzia 3 anni	<i>Warranty 3 years</i>
Fabbricata 100% in Italia	<i>Handcrafted 100% in Italy</i>
Certificazione MED su richiesta	<i>MED certification on request</i>

CODICI ORDINAZIONE / *ORDER CODES* **senza cover protettiva / *without protective cover***

- 62.00053.01** Nera 5° Rosa nera Alta velocità / *Black 5° Black card - high speed*
- 62.00053.10** Nera 5° Rosa rossa Alta velocità / *Black 5° Red card - high speed*
- 62.00142.01** Nera 2° Rosa nera Alta velocità / *Black 2° Black card - high speed*
- 62.00052.01** Nera 5° Rosa nera / *Black 5° Black card*
- 62.00051.01** Nera 2° Rosa nera / *Black 2° Black card*

Riviera **WHITE STAR 5"** **BW1**

Su richiesta / *On request*



DM 587/200
incluso / *included.*



Linea di fede bianca
White Lubber line

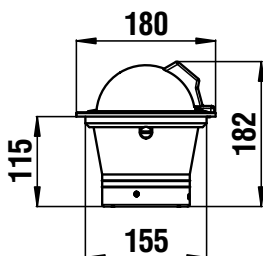

Rosa 5° *Card graduations 5°*



Rosa 2° *Card graduations 2°*

Nera/*Black*

Colori bussola / *compass colors*

BW1 installazione ad incasso orizzontale / *Horizontal flush mounted*

CARATTERISTICHE / *KEY FEATURES*

Sospensione: Cardanica interna	<i>Gimbal type: Internally gimbalead</i>
Illuminazione: 24V di serie (12V a richiesta)	<i>Lighting: 24V standard (12V on request)</i>
Letture: Posteriore - linea di fede bianca	<i>Reading: Rear - white lubber line</i>
Divisione rosa: 5° - 2°	<i>Card graduations: 5° - 2°</i>
Diametro apparente: 5" - 130 mm	<i>Apparent card dia: 5" - 130 mm</i>
Per imbarcazioni ad alta velocità / normali	<i>For high speed boats / standard</i>
Compensazione incorporata	<i>Built-in compensation setting</i>
Schermo antiriflesso	<i>Anti-glare screen</i>
100% Riparabile	<i>100% Repairable</i>
Garanzia 3 anni	<i>Warranty 3 years</i>
Fabbricata 100% in Italia	<i>Handcrafted 100% in Italy</i>
Certificazione MED su richiesta	<i>MED certification on request</i>

CODICI ORDINAZIONE / *ORDER CODES*

- 62.00013.01** Nera 5° Rosa nera - Alta velocità / *Black 5° Black card - high speed*
- 62.00013.10** Nera 5° Rosa rossa - Alta velocità / *Black 2° Red card - high speed*
- 62.00015.01** Nera 2° Rosa nera - Alta velocità / *Black 2° Black card - high speed*
- 62.00017.01** Nera 5° Rosa nera / *Black 5° Black card*
- 62.00019.01** Nera 2° Rosa nera / *Black 2° Black card*



Riviera

BUSSOLE MAGNETICHE
MAGNETIC COMPASSES



COMPASSES - URANIA 4"

URANIA 4"



Bussola magnetica installazione a chiesuola
Binnacle mounted magnetic compass

BU9

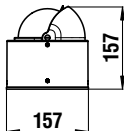

BU6-7

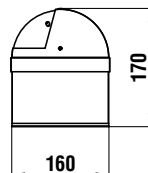

BU5

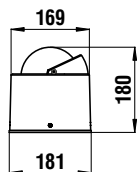

BU4

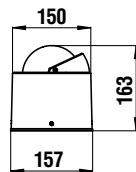

BU2

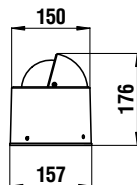

Bussola magnetica installazione a incasso orizzontale
Horizontal flush mounted magnetic compass

BU1

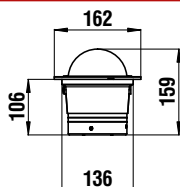

BU10

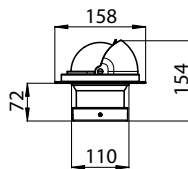

BU8

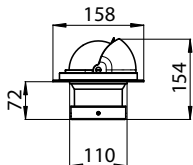

BU3

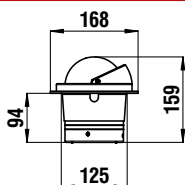



URANIA 4"

CARATTERISTICHE GENERALI / STANDARD FEATURES

Diametro apparente 4" - 100 mm
 Lettura: Posteriore - Frontale
 Sospensione: Cardanica Interna
 Rosa: Nera-Rossa-Bianca 5° - 2°
 Illuminazione 12V (24V su richiesta)
 Per imbarcazioni ad alta velocità/normali
 Compensazione incorporata
 Schermo antiriflesso
 100% Riparabile
 Garanzia 3 anni
 Fabbricata 100% in Italia
 Certificazione MED su richiesta

Apparent card diameter 4" - 100 mm
 Reading : Rear - Direct
 Gymbal type: Internally gimbaled
 Card : Black-Red-White 5° - 2°
 Lighting 12V (24V on request)
 For high speed boats/standard
 Built-in compensation setting
 Anti-glare screen
 100% Repairable
 Warranty 3 years
 Handcrafted 100% in Italy
 MED certification on request



OMOLOGAZIONI E CERTIFICATI / HOMOLOGATIONS AND CERTIFICATES

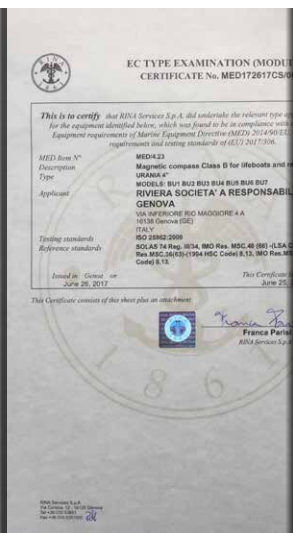
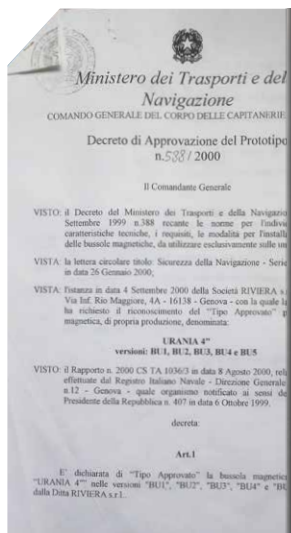

COMPASSES - URANIA 4"

1

In base al Decreto Ministeriale del 29 settembre 1999 n. 388 per strumentazione di sicurezza per barche da diporto fuori dalle 6 miglia, Riviera ha avuto l'approvazione con il Decreto Ministeriale di approvazione del prototipo 588/2000 per bussole Urania 4".

Under ministerial decree (Decree for safety equipment for boats out to six miles) Riviera has been approved by Ministry of Transport and Navigation for compasses Urania 4" with DAP 588/2000.

2

Su richiesta On request

Certificato MED in accordo con la direttiva MED 2014/90/EU riguardo alle imbarcazioni di salvataggio e battelli di emergenza.

MED Certification
 According to the directive MED 2014/90/EU, regarding lifeboats and rescue boats

3

Su richiesta On request

Certificazione tipo approvato RINA per imbarcazioni da pesca e da lavoro inferiori a 150 GT.

RINA type approval certificate for merchant ships and fishing vessels of less than 150 GT



Linea di fede rossa
Red Lubber line

Copertura telescopica.
Telescopic cover

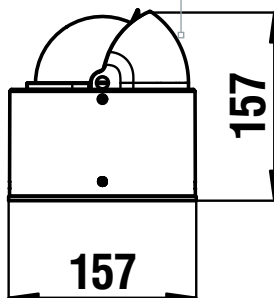

Rosa 5° *Card graduations 5°*



Rosa 5° *Card graduations 5°*

Bianca/*White*

Nera/*Black*

Colori bussola / *compass colors*

BU9 installazione a chiesuola / Binnacle mounted

CARATTERISTICHE / KEY FEATURES

Sospensione: Cardanica interna	<i>Gimbal type: Internally gimbalead</i>
Illuminazione: 12V di serie (24V a richiesta)	<i>Lighting: 12V standard (24V on request)</i>
Lettura: Posteriore - linea di fede rossa	<i>Reading: Rear - red lubber line</i>
Divisione rosa: 5°	<i>Card graduations: 5°</i>
Diametro apparente: 4" - 100 mm	<i>Apparent card dia: 4" - 100 mm</i>
Per imbarcazioni ad alta velocità / normali	<i>For high speed boats / standard</i>
Compensazione incorporata	<i>Built-in compensation setting</i>
Schermo antiriflesso + copertura	<i>Anti-glare screen + cover</i>
100% Riparabile	<i>100% Repairable</i>
Garanzia 3 anni	<i>Warranty 3 years</i>
Fabbricata 100% in Italia	<i>Handcrafted 100% in Italy</i>

CODICI ORDINAZIONE / ORDER CODES

- 62.00644.10** Nera 5° Rosa nera - Alta velocità - Con cop. / *Black 5° Black card - high speed-Prot. cover*
- 62.00644.11** Bianca 5° Rosa nera - Alta velocità - Con cop / *White 5° Black card - high speed-Prot. cover*
- 62.00644.30** Bianca 5° Rosa blu - Alta velocità - Con cop / *White 5° Blue card - high speed-Prot. cover*
- 62.00644.00** Nera 5° Rosa nera - con copertura / *Black 5° Black card - with protective cover*
- 62.00644.01** Bianca 5° Rosa nera - con copertura / *White 5° Black card - with protective cover*
- 62.00644.05** Bianca 5° Rosa blu - con copertura / *White 5° Blue card - with protective cover*



URANIA 4"

Riviera **BU6-7**

Su richiesta / On request



DM 588/200
incluso / included.



BU6 Linea di fede bianca
White Lubber line

BU7 Linea di fede rossa
Red Lubber line

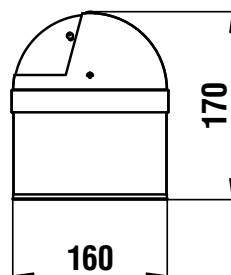

Rosa 5° / *Card graduations 5°*

Inox/*Stainless*

Colori bussola / *compass colors*

BU6-7 installazione a chiesuola / *Binnacle mounted*

CARATTERISTICHE / *KEY FEATURES*

Sospensione: Cardanica interna	<i>Gimbal type: Internally gimbaled</i>
Illuminazione: 12V di serie (24V a richiesta)	<i>Lighting: 12V standard (24V on request)</i>
Letture: Posteriore - linea di fede rossa	<i>Reading: Rear - red lubber line</i>
Divisione rosa: 5°	<i>Card graduations: 5°</i>
Diametro apparente: 4" - 100 mm	<i>Apparent card dia: 4" - 100 mm</i>
Per imbarcazioni ad alta velocità / normali	<i>For high speed boats / standard</i>
Compensazione incorporata	<i>Built-in compensation setting</i>
Schermo antiriflesso	<i>Anti-glare screen</i>
100% Riparabile	<i>100% Repairable</i>
Garanzia 3 anni	<i>Warranty 3 years</i>
Fabbricata 100% in Italia	<i>Handcrafted 100% in Italy</i>
Certificazione MED su richiesta	<i>MED certification on request</i>

CODICI ORDINAZIONE / *ORDER CODES*

- 62.00126.01** Inox 5° Rosa nera - Alta velocità - Linea di fede bianca BU6 / *SST 5° Black card - high speed - White lubber line BU6*
- 62.00125.01** Inox 5° Rosa nera - Linea di fede bianca BU6 / *Stainless steel 5° Black card - White lubber line*
- 62.00128.01** Inox 5° Rosa nera - Alta velocità - Linea di fede rossa BU7 / *SST 5° Black card - high speed - Red lubber line BU7*
- 62.00127.01** Inox 5° Rosa nera - Linea di fede rossa BU7 / *Stainless steel 5° Black card - Red lubber line BU7*

Accessori
Accessories



Coperchio di
protezione inox

*Protective cover
stainless steel*

62.00156.01

COMPASSES - URANIA 4"



Linea di fede rossa
Red Lubber line

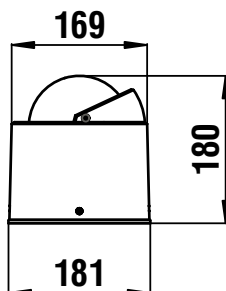

Rosa 5° / Card graduations 5°



Rosa 2° / Card graduations 2°

Bianca/White

Nera/Black

Colori bussola / compass colors

BU5 installazione a chiesuola / Binnacle mounted

CARATTERISTICHE / KEY FEATURES

Sospensione: Cardanica interna	<i>Gimbal type: Internally gimbalead</i>
Illuminazione: 12V di serie (24V a richiesta)	<i>Lighting: 12V standard (24V on request)</i>
Letture: Posteriore - linea di fede rossa	<i>Reading: Rear - red lubber line</i>
Divisione rosa: 5° - 2°	<i>Card graduations: 5° - 2°</i>
Diametro apparente: 4" - 100 mm	<i>Apparent card dia: 4" - 100 mm</i>
Per imbarcazioni ad alta velocità / normali	<i>For high speed boats / standard</i>
Compensazione incorporata	<i>Built-in compensation setting</i>
Schermo antiriflesso	<i>Anti-glare screen</i>
100% Riparabile	<i>100% Repairable</i>
Garanzia 3 anni	<i>Warranty 3 years</i>
Fabbricata 100% in Italia	<i>Handcrafted 100% in Italy</i>
Certificazione MED su richiesta	<i>MED certification on request</i>

CODICI ORDINAZIONE / ORDER CODES

- 62.00158.01 Nera 5° Rosa nera - Alta velocità / *Black 5° Black card - high speed*
- 62.00158.10 Nera 5° Rosa rossa - Alta velocità / *Black 5° Red card - high speed*
- 62.00112.01 Nera 5° Rosa nera / *Black 5° Black card*
- 62.00157.01 Nera 2° Rosa nera / *Black 2° Black card*
- 62.00103.01 Bianca 5° Rosa nera / *White 5° Black card*

Accessori Accessories



Calotta di protezione in tela

Protective cover
Canvas hood

62.00062.01



URANIA 4"

Riviera **BU4**

Su richiesta / *On request*



DM 588/200
incluso / *included.*



Linea di fede rossa
Red Lubber line

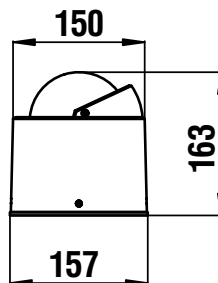

Rosa 5° / *Card graduations 5°*



Rosa 2° / *Card graduations 2°*

Bianca/*White*

Nera/*Black*

Colori bussola / *compass colors*

BU4 installazione a chiesuola / *Binnacle mounted*

CARATTERISTICHE / *KEY FEATURES*

Sospensione: Cardanica interna	<i>Gimbal type: Internally gimbale</i>
Illuminazione: 12V di serie (24V a richiesta)	<i>Lighting: 12V standard (24V on request)</i>
Letture: Posteriore - linea di fede rossa	<i>Reading: Rear - red lubber line</i>
Divisione rosa: 5° - 2°	<i>Card graduations: 5° - 2°</i>
Diametro apparente: 4" - 100 mm	<i>Apparent card dia: 4" - 100 mm</i>
Per imbarcazioni ad alta velocità / normali	<i>For high speed boats / standard</i>
Compensazione incorporata	<i>Built-in compensation setting</i>
Schermo antiriflesso	<i>Anti-glare screen</i>
100% Riparabile	<i>100% Repairable</i>
Garanzia 3 anni	<i>Warranty 3 years</i>
Fabbricata 100% in Italia	<i>Handcrafted 100% in Italy</i>
Certificazione MED su richiesta	<i>MED certification on request</i>

CODICI ORDINAZIONE / *ORDER CODES*

- 62.00042.01 Nera 5° Rosa nera - Alta velocità / *Black 5° Black card - high speed*
- 62.00042.10 Nera 5° Rosa rossa - Alta velocità / *Black 5° Red card - high speed*
- 62.00041.01 Nera 5° Rosa nera / *Black 5° Black card*
- 62.00150.01 Nera 2° Rosa nera / *Black 2° Black card*
- 62.00507.01 Bianca 5° Rosa bianca / *White 5° White card*

Accessori
Accessories



Calotta di protezione in tela

*Protective cover
Canvas hood*

62.00063.01



Linea di fede rossa
Red Lubber line

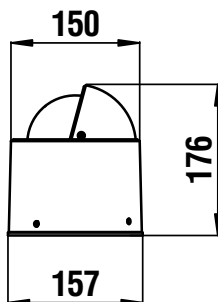

Rosa 5° / Card graduations 5°



Rosa 2° / Card graduations 2°

Bianca/White

Nera/Black

Colori bussola / compass colors

BU2 installazione a chiesuola / Binnacle mounted

CARATTERISTICHE / KEY FEATURES

Sospensione: Cardanica interna	<i>Gimbal type: Internally gimbalead</i>
Illuminazione: 12V di serie (24V a richiesta)	<i>Lighting: 12V standard (24V on request)</i>
Letture: Posteriore - linea di fede rossa	<i>Reading: Rear - red lubber line</i>
Divisione rosa: 5° - 2°	<i>Card graduations: 5° - 2°</i>
Diametro apparente: 4" - 100 mm	<i>Apparent card dia: 4" - 100 mm</i>
Per imbarcazioni ad alta velocità / normali	<i>For high speed boats / standard</i>
Compensazione incorporata	<i>Built-in compensation setting</i>
Schermo antiriflesso	<i>Anti-glare screen</i>
100% Riparabile	<i>100% Repairable</i>
Garanzia 3 anni	<i>Warranty 3 years</i>
Fabbricata 100% in Italia	<i>Handcrafted 100% in Italy</i>
Certificazione MED su richiesta	<i>MED certification on request</i>

CODICI ORDINAZIONE / ORDER CODES

- 62.00038.01** Nera 5° Rosa nera - Alta velocità / *Black 5° Black card - high speed*
- 62.00038.10** Nera 5° Rosa rossa - Alta velocità / *Black 5° Red card - high speed*
- 62.00037.01** Nera 5° Rosa nera / *Black 5° Black card*
- 62.00152.01** Nera 2° Rosa nera / *Black 2° Black card*
- 62.00506.01** Bianca 5° Rosa bianca / *White 5° White card*

Accessori
Accessories



Calotta di protezione in tela

Protective cover
Canvas hood

62.00063.01



URANIA 4"

Riviera **BU8**



Linea di fede rossa
Red Lubber line

Copertura telescopica.
Telescopic cover

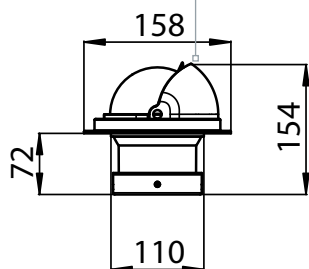

Rosa 5° *Card graduations 5°*



Rosa 5° *Card graduations 5°*

Bianca/*White*

Nera/*Black*

Colori bussola / *compass colors*

BU8 installazione ad incasso orizzontale / *Horizontal flush mounted*

CARATTERISTICHE / *KEY FEATURES*

Sospensione: Cardanica interna	<i>Gimbal type: Internally gimbaled</i>
Illuminazione: 12V di serie (24V a richiesta)	<i>Lighting: 12V standard (24V on request)</i>
Lettura: Posteriore - linea di fede rossa	<i>Reading: Rear - red lubber line</i>
Divisione rosa: 5°	<i>Card graduations: 5°</i>
Diametro apparente: 4" - 100 mm	<i>Apparent card dia: 4" - 100 mm</i>
Per imbarcazioni ad alta velocità / normali	<i>For high speed boats / standard</i>
Compensazione incorporata	<i>Built-in compensation setting</i>
Schermo antiriflesso	<i>Anti-glare screen</i>
100% Riparabile	<i>100% Repairable</i>
Garanzia 3 anni	<i>Warranty 3 years</i>
Fabbricata 100% in Italia	<i>Handcrafted 100% in Italy</i>

CODICI ORDINAZIONE / *ORDER CODES*

62.00652.10 Nera 5° Rosa nera - Alta velocità - con copertura / <i>Black 5° Black card - high speed - whit Protective cover</i>
62.00652.11 Bianca 5° Rosa nera - Alta velocità - con copertura / <i>White 5° Black card - high speed - whit Protective cover</i>
62.00652.30 Bianca 5° Rosa blu - Alta velocità - con copertura / <i>White 5° Blue card - high speed - whit Protective cover</i>
62.00652.00 Nera 5° Rosa nera - con copertura / <i>Black 5° Black card - whit Protective cover</i>
62.00652.01 Bianca 5° Rosa nera - con copertura / <i>White 5° Black card - whit Protective cover</i>
62.00652.03 Bianca 5° Rosa blu - con copertura / <i>White 5° Blue card - whit Protective cover</i>



Linea di fede rossa
Red Lubber line

Copertura telescopica.
Telescopic cover

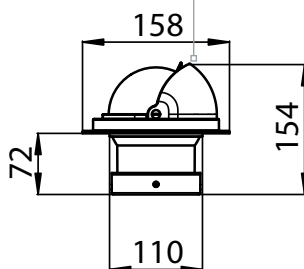

Rosa 5° / *Card graduations 5°*

Rosa 5° *Card graduations 5°*

Bianca/*White*

Nera/*Black*

Colori bussola / *compass colors*

BU10 installazione ad incasso orizzontale / Horizontal flush mounted

CARATTERISTICHE / KEY FEATURES

Sospensione: Cardanica interna	<i>Gimbal type: Internally gimbale</i>
Illuminazione: 12V di serie (24V a richiesta)	<i>Lighting: 12V standard (24V on request)</i>
Letture: Frontale - linea di fede rossa	<i>Reading: Direct - red lubber line</i>
Divisione rosa: 5°	<i>Card graduations: 5°</i>
Diametro apparente: 4" - 100 mm	<i>Apparent card dia: 4" - 100 mm</i>
Per imbarcazioni ad alta velocità / normali	<i>For high speed boats / standard</i>
Compensazione incorporata	<i>Built-in compensation setting</i>
Schermo antiriflesso + copertura	<i>Anti-glare screen + cover</i>
100% Riparabile	<i>100% Repairable</i>
Garanzia 3 anni	<i>Warranty 3 years</i>
Fabbricata 100% in Italia	<i>Handcrafted 100% in Italy</i>

CODICI ORDINAZIONE / ORDER CODES

- 62.00744.00** Nera 5° Rosa nera - Alta velocità - con copertura / *Black 5° Black card - high speed - whit Protective cover*
- 62.00744.01** Bianca 5° Rosa nera - Alta velocità - con copertura / *White 5° Black card - high speed - whit Protective cover*
- 62.00744.02** Bianca 5° Rosa blu - Alta velocità - con copertura / *White 5° Blue card - high speed - whit Protective cover*
- 62.00744.03** Nera 5° Rosa blu - Alta velocità - con copertura / *Black 5° Blue card - high speed - whit Protective cover*



URANIA 4"

Riviera **BU3**

Su richiesta / *On request*



DM 588/200
incluso / *included.*



Linea di fede rossa
Red Lubber line

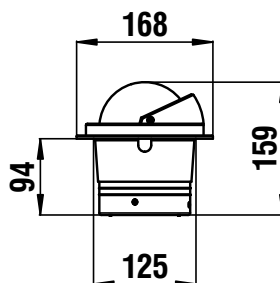

Rosa 5° / *Card graduations 5°*



Rosa 2° / *Card graduations 2°*

Bianca/*White*

Nera/*Black*

Colori bussola / *compass colors*

BU3 installazione ad incasso orizzontale / *Horizontal flush mounted*

CARATTERISTICHE / *KEY FEATURES*

Sospensione: Cardanica interna	<i>Gimbal type: Internally gimbale</i>
Illuminazione: 12V di serie (24V a richiesta)	<i>Lighting: 12V standard (24V on request)</i>
Lettura: Posteriore - linea di fede rossa	<i>Reading: Rear - red lubber line</i>
Divisione rosa: 5° - 2°	<i>Card graduations: 5° - 2°</i>
Diametro apparente: 4" - 100 mm	<i>Apparent card dia: 4" - 100 mm</i>
Per imbarcazioni ad alta velocità / normali	<i>For high speed boats / standard</i>
Compensazione incorporata	<i>Built-in compensation setting</i>
Schermo antiriflesso	<i>Anti-glare screen</i>
100% Riparabile	<i>100% Repairable</i>
Garanzia 3 anni	<i>Warranty 3 years</i>
Fabbricata 100% in Italia	<i>Handcrafted 100% in Italy</i>
Certificazione MED su richiesta	<i>MED certification on request</i>

CODICI ORDINAZIONE / *ORDER CODES*

62.00040.01 Nera 5° Rosa nera - Alta velocità / <i>Black 5° Black card - high speed</i>
62.00040.10 Nera 5° Rosa rossa - Alta velocità / <i>Black 5° Red card - high speed</i>
62.00039.01 Nera 5° Rosa nera / <i>Black 5° Black card</i>
62.00153.01 Nera 2° Rosa nera / <i>Black 2° Black card</i>
62.00321.01 Bianca 5° Rosa blu - Alta velocità / <i>White 5° Blue card - high speed</i>



Linea di fede rossa
Red Lubber line

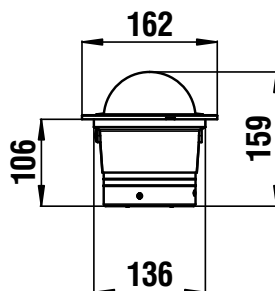

Rosa 5° / Card graduations 5°



Rosa 2° / Card graduations 2°

Bianca/White

Nera/Black

Colori bussola / compass colors

BU1 installazione ad incasso orizzontale / Horizontal flush mounted

CARATTERISTICHE / KEY FEATURES

Sospensione: Cardanica interna	<i>Gimbal type: Internally gimbalead</i>
Illuminazione: 12V di serie (24V a richiesta)	<i>Lighting: 12V standard (24V on request)</i>
Letture: Posteriore - linea di fede rossa	<i>Reading: Rear - red lubber line</i>
Divisione rosa: 5° - 2°	<i>Card graduations: 5° - 2°</i>
Diametro apparente: 4" - 100 mm	<i>Apparent card dia: 4" - 100 mm</i>
Per imbarcazioni ad alta velocità / normali	<i>For high speed boats / standard</i>
Compensazione incorporata	<i>Built-in compensation setting</i>
100% Riparabile	<i>100% Repairable</i>
Garanzia 3 anni	<i>Warranty 3 years</i>
Fabbricata 100% in Italia	<i>Handcrafted 100% in Italy</i>
Certificazione MED su richiesta	<i>MED certification on request</i>

CODICI ORDINAZIONE / ORDER CODES

- 62.00036.01 Nera 5° Rosa nera - Alta velocità / **Black 5° Black card - high speed**
- 62.00036.10 Nera 5° Rosa rossa - Alta velocità / **Black 5° Red card - high speed**
- 62.00035.01 Nera 5° Rosa nera / **Black 5° Black card**
- 62.00151.01 Nera 2° Rosa nera / **Black 2° Black card**
- 62.00318.01 Bianca 5° Rosa bianca / **White 5° White card**

Accessori
Accessories



Coperchio di protezione bianco

Protective cover
Canvas hood

62.00048.01



Riviera

BUSSOLE MAGNETICHE
MAGNETIC COMPASSES



COMPASSES - ASTRA 4"

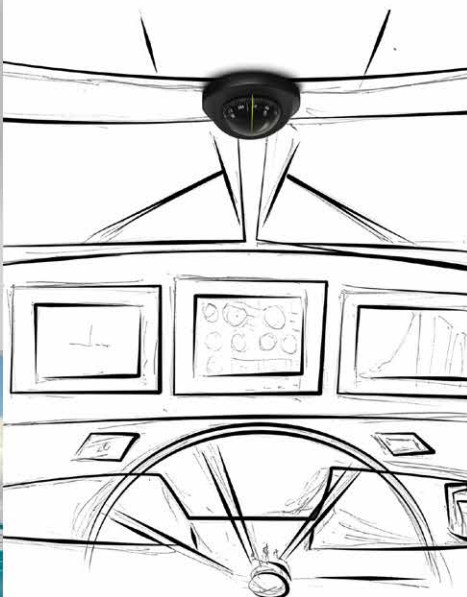

La nuova bussola Astra è stata ideata per soddisfare le esigenze dei cantieri alla continua ricerca di ottimizzazione degli spazi sulle plance di comando, sempre più ricche di monitor, indicatori vari e strumentazione elettronica di ogni tipo. L'obiettivo è quello di sfruttare superfici inutilizzate ovvero, in questo caso, il cielino delle imbarcazioni prospiciente alla plancia.

It's a new magnetic compass made specifically for ceiling mounting. ASTRA is the result of years of research and development in the sector of compasses for both Yachts and Work boats. The aim was to make a compass with particular installation that could satisfy the requirements of shipyards who are continuously seeking to optimize space on the bridge which is increasingly cluttered with monitors and magnetic disturbing influence.





ASTRA 4"

Riviera **BAS1**



Linea di fede rossa
Red Lubber line

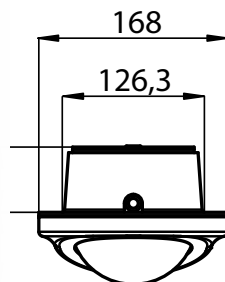

Rosa 5° / *Card graduations 5°*

Bianca/*White*

Nera/*Black*

Colori bussola / *compass colors*

BAS1 installazione ad incasso a soffitto / *Over head flush mounted*

NEW

CARATTERISTICHE / *KEY FEATURES*

Sospensione: Cardanica interna	<i>Gimbal type: Internally gimbaled</i>
Illuminazione: 12V di serie (24V a richiesta)	<i>Lighting: 12V standard (24V on request)</i>
Lettura: Frontale - linea di fede rossa	<i>Reading: Direct - red lubber line</i>
Divisione rosa: 5°	<i>Card graduations: 5°</i>
Diametro apparente: 4" - 100 mm	<i>Apparent card dia: 4" - 100 mm</i>
Per imbarcazioni ad alta velocità / normali	<i>For high speed boats / standard</i>
Compensazione incorporata	<i>Built-in compensation setting</i>
Schermo antiriflesso	<i>Anti-glare screen</i>
100% Riparabile	<i>100% Repairable</i>
Garanzia 3 anni	<i>Warranty 3 years</i>
Fabbricata 100% in Italia	<i>Handcrafted 100% in Italy</i>

CODICI ORDINAZIONE / *ORDER CODES*

- 62.00854.00** Nera 5° Rosa nera / *Black 5° Black card*
- 62.00854.01** Nera 5° Rosa nera – Alta velocità / *Black 5° Black card - high speed*
- 62.00854.02** Bianca 5° Rosa nera / *White 5° Black card*
- 62.00854.03** Bianca 5° Rosa nera – Alta velocità / *White 5° Black card - high speed*



Riviera

BUSSOLE MAGNETICHE MAGNETIC COMPASSES



COMPASSES - POLARE 4" & 3"



POLARE 4" & 3"

CARATTERISTICHE GENERALI / STANDARD FEATURES

Diametro apparente 4" - 100 mm/ 3" - 80 mm
 Lettura: Frontale
 Gymbal type: Cardanica Interna
 Rosa: Nera, bianca, blu,rossa 5°
 Illuminazione 12V (24V su richiesta)
 Compensazione incorporata
 Schermo antiriflesso
 100% Riparabile
 Garanzia 3 anni
 Fabbricata 100% in Italia
 Certificazione MED su richiesta

Apparent card diameter 4" - 100 mm/ 3" - 80 mm
 Reading : Direct
 Gymbal type: Internally gimbaled
 Card: Black,white,red,blue 5°
 Lighting 12V (24V su richiesta/on request)
 Built-in compensation setting
 Anti-glare screen
 100% Repairable
 Warranty 3 years
 Handcrafted 100% in Italy
 MED certification on request



NON NECESSITA DI OMOLOGAZIONE PER NAVIGAZIONE ENTRO LE 6 MIGLIA
 NO APPROVALS NEEDED FOR NAVIGATION WITHIN 6 MILES

OMOLOGAZIONI E CERTIFICATI / HOMOLOGATIONS AND CERTIFICATES

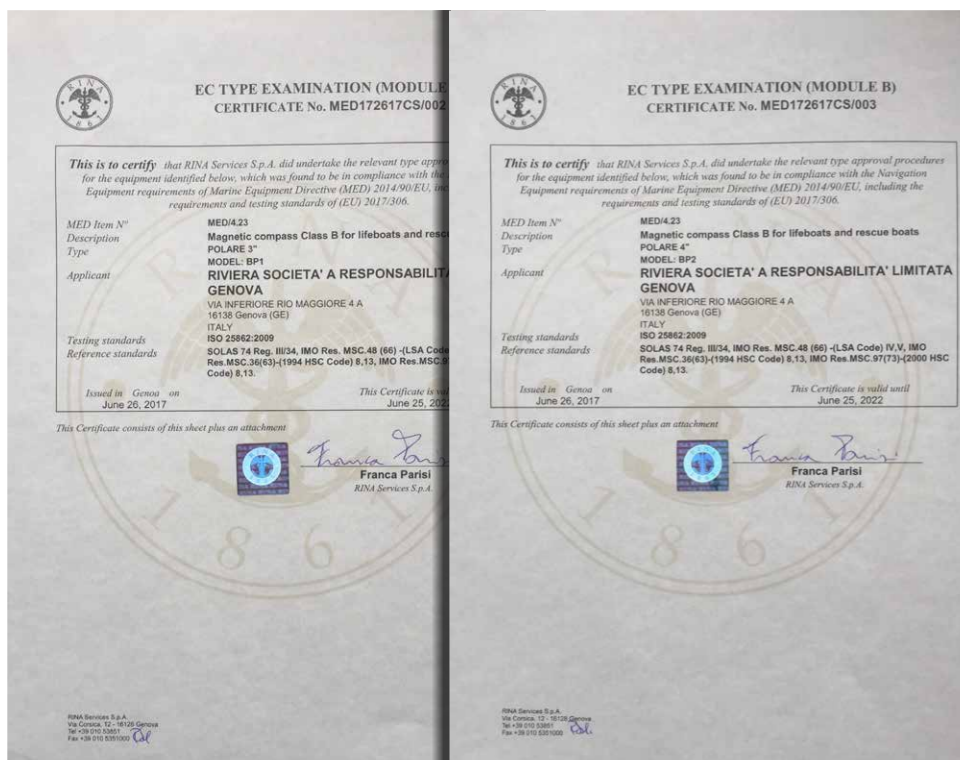

COMPASSES - POLARE 4" & 3"

Su richiesta *On request*

Certificato MED
 in accordo con la direttiva MED 2014/90/EU
 riguardo alle imbarcazioni di salvataggio e battelli
 di emergenza.

MED Certification
 According to the directive MED 2014/90/EU,
 regarding lifeboats and rescue boats



Linea di fede rossa
Red Lubber line

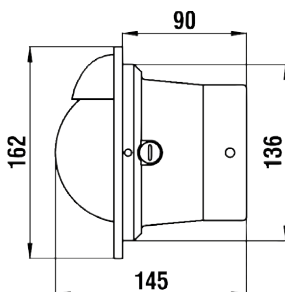

Rosa 5° / Card graduations 5°

Bianca/White

Nera/Black

Colori bussola / compass colors

BP2 installazione ad incasso verticale / Bulkhead mounted

CARATTERISTICHE / KEY FEATURES

Sospensione: Cardanica interna	<i>Gimbal type: Internally gimballed</i>
Illuminazione: 12V di serie (24V a richiesta)	<i>Lighting: 12V standard (24V on request)</i>
Letture: Frontale - linea di fede rossa	<i>Reading: Direct - red lubber line</i>
Divisione rosa: 5°	<i>Card graduations: 5°</i>
Diametro apparente: 4" - 100 mm	<i>Apparent card dia: 4" - 100 mm</i>
Per imbarcazioni ad alta velocità / normali	<i>For high speed boats / standard</i>
Compensazione incorporata	<i>Built-in compensation setting</i>
100% Riparabile	<i>100% Repairable</i>
Garanzia 3 anni	<i>Warranty 3 years</i>
Fabbricata 100% in Italia	<i>Handcrafted 100% in Italy</i>
Certificazione MED su richiesta	<i>MED certification on request</i>

CODICI ORDINAZIONE / ORDER CODES

- 62.00773.00 Bianca Rosa nera / White Black card
- 62.00773.01 Bianca Rosa bianca / White White card
- 62.00773.04 Bianca Rosa rossa / White Red card
- 62.00773.05 Bianca Rosa blu / White Blue card
- 62.00773.02 Nera Rosa nera / Black Black card
- 62.00773.03 Nera Rosa bianca / Black White card
- 62.00773.06 Nera Rosa rossa / Black Red card
- 62.00773.07 Nera Rosa blu / Black Blue card

**Accessori
Accessories**





POLARE 3"

Riviera **BP1**

Su richiesta / On request



Certificato MED
MED certification



Linea di fede rossa
Red Lubber line

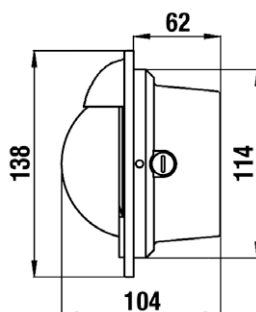

Rosa 5° / Card graduations 5°

Bianca/White

Nera/Black

Colori bussola / compass colors

BP1 installazione ad incasso verticale / Bulkhead mounted

CARATTERISTICHE / KEY FEATURES

Sospensione: Cardanica interna

Gimbal type: Internally gimbale

Illuminazione: 12V di serie (24V a richiesta)

Lighting: 12V standard (24V on request)

Letture: Frontale - linea di fede rossa

Reading: Direct - red lubber line

Divisione rosa: 5°

Card graduations: 5°

Diametro apparente: 3" - 80 mm

Apparent card dia: 3" - 80 mm

Per imbarcazioni ad alta velocità / normali

For high speed boats / standard

Compensazione incorporata

Built-in compensation setting

100% Riparabile

100% Repairable

Garanzia 3 anni

Warranty 3 anni/years

Fabbricata 100% in Italia

Handcrafted 100% in Italy

Certificazione MED su richiesta

MED certification on request

CODICI ORDINAZIONE / ORDER CODES

62.00785.00 Bianca Rosa nera / *White Black card*

62.00785.04 Nera Rosa nera / *Black Black card*

62.00785.01 Bianca Rosa bianca / *White White card*

62.00785.05 Nera Rosa bianca / *Black White card*

62.00785.02 Bianca Rosa rossa / *White Red card*

62.00785.06 Nera Rosa rossa / *Black Red card*

62.00785.03 Bianca Rosa blu / *White Blue card*

62.00785.07 Nera Rosa blu / *Black Blue card*

COMPASSES - POLARE 3"

Accessori
Accessories



60.03272.10

Calotta
di protezione

Protection
cover





Riviera

**BUSSOLE MAGNETICHE
MAGNETIC COMPASSES**



COMPASSES - ZENITH 3"



ZENITH 3"

Lettura posteriore/Rear reading

Lettura frontale/Direct reading

Bussola magnetica a incasso orizzontale
Horizontal flush mounted magnetic compass

BZ1

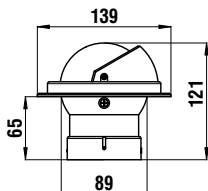

BZ1

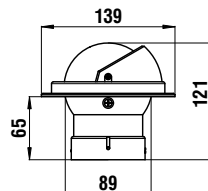

BZ1

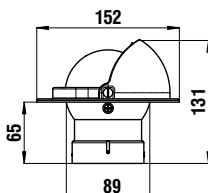

BZ4

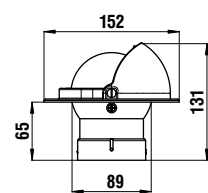

BZT

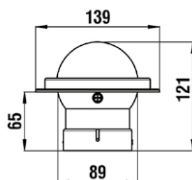

Bussola magnetica con supporto a staffa
Bracket mounted magnetic compass

BZ2

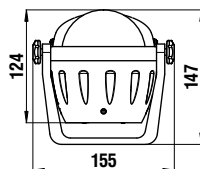

BZ2

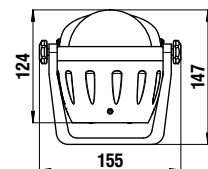

Bussola magnetica installazione a chiesuola
Binnacle mounted magnetic compass

BZ3

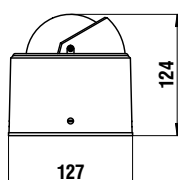

BZ3

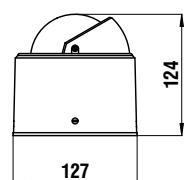

CARATTERISTICHE GENERALI / STANDARD FEATURES



Diametro apparente 3" - 80 mm
 Lettura : Posteriore - Frontale
 Sospensione : Cardanica Interna
 Rosa: Nera, blu 5°
 Illuminazione 12V (24V su richiesta)
 Per imbarcazioni ad alta velocità
 Compensazione incorporata
 Schermo antiriflesso
 100% Riparabile
 Garanzia 3 anni
 Fabbricata 100% in Italia
 Certificazione MED su richiesta

Apparent card diameter 3" - 80 mm
 Reading : Rear - Direct
 Gymbal type: Internally gimbaled
 Card : Black, blue 5°
 Lighting 12V (24V on request)
 For high speed boats
 Built-in compensation setting
 Anti-glare screen
 100% Repairable
 Warranty 3 years
 Handcrafted 100% in Italy
 MED certification on request

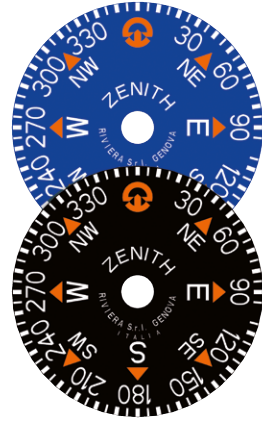

NON NECESSITA DI OMOLOGAZIONE PER NAVIGAZIONE ENTRO LE 6 MIGLIA

NO APPROVALS NEEDED FOR NAVIGATION WITHIN 6 MILES

OMOLOGAZIONI E CERTIFICATI / HOMOLOGATIONS AND CERTIFICATES



Su richiesta **On request**

Certificato MED
 in accordo con la direttiva MED
 2014/90/EU riguardo alle imbarcazioni di
 salvataggio e battelli di emergenza.

MED Certification
 According to the directive MED 2014/90/
 EU, regarding lifeboats and rescue boats

139 COMPASSES - ZENITH 3"



ZENITH 3"

Riviera **BZ1**



Rosa 5° / Card graduations 5°

Su richiesta / On request



Certificato MED
MED certification

Linea di fede bianca
White Lubber line

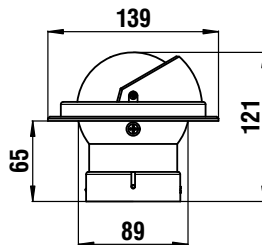

senza cover/without cover

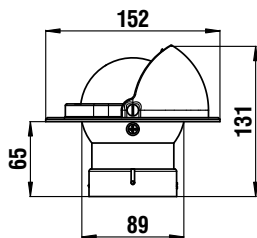

con cover/with cover

Bianca/White

Grigia/Grey

Nera/Black

Colori bussola / compass colors

BZ1 installazione ad incasso orizzontale / Horizontal flush mounted

CARATTERISTICHE / KEY FEATURES

Sospensione: Cardanica interna	<i>Gimbal type: Internally gimballed</i>
Illuminazione: 12V di serie (24V a richiesta)	<i>Lighting: 12V standard (24V on request)</i>
Lettura: Posteriore	<i>Reading: Rear</i>
Divisione rosa: 5°	<i>Card graduations: 5°</i>
Diametro apparente: 3" - 80 mm	<i>Apparent card dia: 3" - 80 mm</i>
Per imbarcazioni ad alta velocità / normali	<i>For high speed boats / standard</i>
Compensazione incorporata	<i>Built-in compensation setting</i>
100% Riparabile	<i>100% Repairable</i>
Garanzia 3 anni	<i>Warranty 3 years</i>
Fabbricata 100% in Italia	<i>Handcrafted 100% in Italy</i>
Certificazione MED su richiesta	<i>MED certification on request</i>

CODICI ORDINAZIONE / ORDER CODES **senza cover protettiva / without protective cover**

- 62.00144.01 Nera Rosa nera / *Black Black card*
- 62.00311.01 Grigia Rosa blu / *Grey Blue card*
- 62.00311.02 Bianca Rosa nera / *White Black card*
- 62.00143.01 Nera Rosa nera - Alta velocità / *Black Black card - high speed*
- 62.00309.01 Grigia Rosa blu - Alta velocità / *Grey Blue card - high speed*
- 62.00309.02 Bianca Rosa nera - Alta velocità / *White Black card - high speed*

CODICI ORDINAZIONE / ORDER CODES **con cover protettiva / with protective cover**

- 62.00643.00 Nera Rosa nera / *Black Black card*
- 62.00643.02 Grigia Rosa blu / *Grey Blue card*
- 62.00643.01 Bianca Rosa nera / *White Black card*
- 62.00581.00 Nera Rosa nera - Alta velocità / *Black Black card - high speed*
- 62.00581.02 Grigia Rosa blu - Alta velocità / *Grey Blue card - high speed*
- 62.00581.01 Bianca Rosa nera - Alta velocità / *White Black card - high speed*
- 62.00581.03 Bianca Rosa blu - Alta velocità / *White Blue card - high speed*





Linea di fede rossa
 Red Lubber line

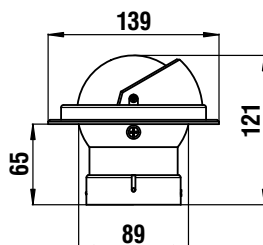

Rosa 5° / Card graduations 5°

Bianca/White

Grigia/Grey

Nera/Black

Colori bussola / compass colors

BZ1 installazione ad incasso orizzontale / Horizontal flush mounted

NEW

CARATTERISTICHE / KEY FEATURES

Sospensione: Cardanica interna	<i>Gimbal type: Internally gimbaled</i>
Illuminazione: 12V di serie (24V a richiesta)	<i>Lighting: 12V standard (24V on request)</i>
Letture: Frontale	<i>Reading: Direct</i>
Divisione rosa: 5°	<i>Card graduations: 5°</i>
Diametro apparente: 3" - 80 mm	<i>Apparent card dia: 3" - 80 mm</i>
Per imbarcazioni ad alta velocità / normali	<i>For high speed boats / standard</i>
Compensazione incorporata	<i>Built-in compensation setting</i>
100% Riparabile	<i>100% Repairable</i>
Garanzia 3 anni	<i>Warranty 3 years</i>
Fabbricata 100% in Italia	<i>Handcrafted 100% in Italy</i>
Certificazione MED su richiesta	<i>MED certification on request</i>

CODICI ORDINAZIONE / ORDER CODES

- 62.00444.01** Nera Rosa nera - Alta velocità / *Black Black card - high speed*
- 62.00445.01** Nera Rosa nera / *Black Black card*
- 62.00444.02** Bianca Rosa nera - Alta velocità / *White Black card - high speed*
- 62.00445.02** Bianca Rosa nera / *White Black card*
- 62.00444.03** Grigia Rosa blu - Alta velocità / *Grey Blue card - high speed*
- 62.00445.03** Grigia Rosa blu / *Grey Blue card*



Riviera

ZENITH 3"

BZ4 *Lettura frontale*
Direct reading

NON NECESSITA DI OMOLOGAZIONE
PER NAVIGAZIONE ENTRO LE 6 MIGLIA
NO APPROVALS NEEDED
FOR NAVIGATION WITHIN 6 MILES



Linea di fede rossa
Red Lubber line

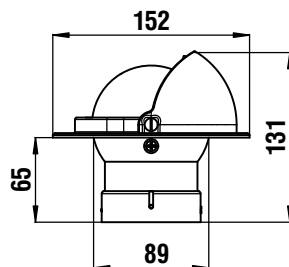

Rosa 5° / *Card graduations 5°*

Bianca/*White*

Grigia/*Grey*

Nera/*Black*

Colori bussola / *compass colors*

BZ4 installazione ad incasso orizzontale / *Horizontal flush mounted*

CARATTERISTICHE / *KEY FEATURES*

Sospensione: A spillo	<i>Gimbal type: Jewel and pivot movements</i>
Illuminazione: 12V di serie (24V a richiesta)	<i>Lighting: 12V standard (24V on request)</i>
Letture: Frontale	<i>Reading: Direct</i>
Divisione rosa: 5°	<i>Card graduations: 5°</i>
Diametro apparente: 3" - 80 mm	<i>Apparent card dia: 3" - 80 mm</i>
Per imbarcazioni ad alta velocità / normali	<i>For high speed boats / standard</i>
Compensazione incorporata	<i>Built-in compensation setting</i>
100% Riparabile	<i>100% Repairable</i>
Garanzia 3 anni	<i>Warranty 3 years</i>
Fabbricata 100% in Italia	<i>Handcrafted 100% in Italy</i>
Certificazione MED su richiesta	<i>MED certification on request</i>

CODICI ORDINAZIONE / *ORDER CODES*

- 62.00745.00 Nera** Rosa nera - Alta velocità - Con cop. / *Black Black card - high speed - Prot. cover*
- 62.00745.02 Grigia** Rosa blu - Alta velocità - Con cop. / *Grey Blue card - high speed - Prot. cover*
- 62.00745.01 Bianca** Rosa blu - Alta velocità - Con cop. / *White Blue card - high speed - Prot. cover*
- 62.00745.03 Bianca** Rosa nera - Alta velocità - Con cop. / *White Black card - high speed - Prot. cover*

Accessori
Accessories



Coperchio di protezione

Protective cover



Linea di fede bianca, funzione tattica
White Lubber line, tactical function

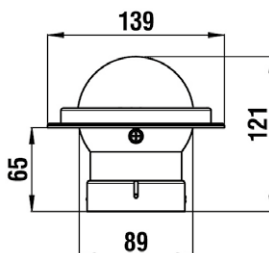

Rosa 5° / *Card graduations 5°*

Bianca/*White*

Grigia/*Grey*

Nera/*Black*

Colori bussola / *compass colors*

BZT installazione ad incasso orizzontale / *Horizontal flush mounted*

CARATTERISTICHE / *KEY FEATURES*

Sospensione: Cardanica interna	<i>Gimbal type: Internally gimbaled</i>
Letture: Posteriore e funzione tattica	<i>Reading: Rear reading and tactical function</i>
Divisione rosa: 5°	<i>Card graduations: 5°</i>
Diametro apparente: 3" - 80 mm	<i>Apparent card dia: 3" - 80 mm</i>
Per imbarcazioni ad alta velocità / normali	<i>For high speed boats / standard</i>
Compensazione incorporata	<i>Built-in compensation setting</i>
100% Riparabile	<i>100% Repairable</i>
Garanzia 3 anni	<i>Warranty 3 years</i>
Fabbricata 100% in Italia	<i>Handcrafted 100% in Italy</i>
Certificazione MED su richiesta	<i>MED certification on request</i>

CODICI ORDINAZIONE / *ORDER CODES*

- 62.00772.00** Nera Rosa tattica / *Black Tactical card*
- 62.00772.01** Bianca Rosa tattica / *White Tactical card*
- 62.00772.02** Grigia Rosa tattica / *Grey Tactical card*

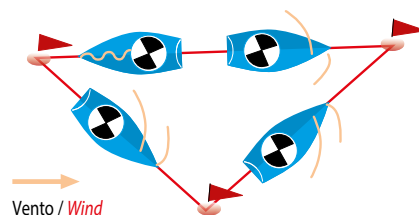

Una sola cifra per le andature di un percorso olimpico
Just 1 number for olympic sailing routers



ZENITH 3"
Riviera **BZ2**

Su richiesta / On request



Certificato MED
MED certification



Linea di fede bianca
White Lubber line

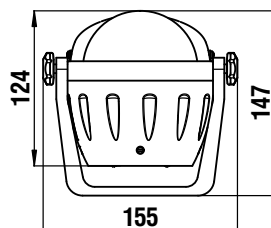

Rosa 5° / Card graduations 5°

Bianca/White

Grigia/Grey

Nera/Black

Colori bussola / compass colors

BZ2 installazione a staffa / Bracket mounted

CARATTERISTICHE / KEY FEATURES

Sospensione: Cardanica interna	<i>Gimbal type: Internally gimbale</i>
Illuminazione: 12V di serie (24V a richiesta)	<i>Lighting: 12V standard (24V on request)</i>
Letture: Posteriore	<i>Reading: Rear</i>
Divisione rosa: 5°	<i>Card graduations: 5°</i>
Diametro apparente: 3" - 80 mm	<i>Apparent card dia: 3" - 80 mm</i>
Per imbarcazioni ad alta velocità / normali	<i>For high speed boats / standard</i>
Compensazione incorporata	<i>Built-in compensation setting</i>
100% Riparabile	<i>100% Repairable</i>
Garanzia 3 anni	<i>Warranty 3 years</i>
Fabbricata 100% in Italia	<i>Handcrafted 100% in Italy</i>
Certificazione MED su richiesta	<i>MED certification on request</i>

CODICI ORDINAZIONE / ORDER CODES

62.00145.01 Nera Rosa nera - Alta velocità / <i>Black Black card - high speed</i>
62.00146.01 Nera Rosa nera / <i>Black Black card</i>
62.00312.01 Grigia Rosa blu - Alta velocità / <i>Grey Blue card - high speed</i>
62.00313.01 Grigia Rosa blu / <i>Grey Blue card</i>
62.00312.02 Bianca Rosa nera - Alta velocità / <i>White Black card - high speed</i>
62.00313.02 Bianca Rosa nera / <i>White Black card</i>



Linea di fede rossa
 Red Lubber line

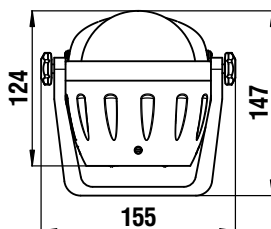

Rosa 5° / Card graduations 5°

Bianca/White

Grigia/Grey

Nera/Black

Colori bussola / compass colors

BZ2 installazione a staffa / Bracket mounted

NEW

CARATTERISTICHE / KEY FEATURES

Sospensione: Cardanica interna	<i>Gimbal type: Internally gimbaled</i>
Illuminazione: 12V di serie (24V a richiesta)	<i>Lighting: 12V standard (24V on request)</i>
Letture: Frontale	<i>Reading: Direct</i>
Divisione rosa: 5°	<i>Card graduations: 5°</i>
Diametro apparente: 3" - 80 mm	<i>Apparent card dia: 3" - 80 mm</i>
Per imbarcazioni ad alta velocità / normali	<i>For high speed boats / standard</i>
Compensazione incorporata	<i>Built-in compensation setting</i>
100% Riparabile	<i>100% Repairable</i>
Garanzia 3 anni	<i>Warranty 3 years</i>
Fabbricata 100% in Italia	<i>Handcrafted 100% in Italy</i>
Certificazione MED su richiesta	<i>MED certification on request</i>

CODICI ORDINAZIONE / ORDER CODES

- 62.00446.01** Nera Rosa nera - Alta velocità / *Black Black card - high speed*
- 62.00447.01** Nera Rosa nera / *Black Black card*
- 62.00446.02** Bianca Rosa nera - Alta velocità / *White Black card - high speed*
- 62.00447.02** Bianca Rosa nera / *White Black card*
- 62.00446.03** Grigia Rosa blu - Alta velocità / *Grey Blue card - high speed*
- 62.00447.03** Grigia Rosa blu / *Grey blue card*



ZENITH 3"

Riviera **BZ3**

Su richiesta / *On request*



Certificato MED
MED certification



Linea di fede bianca
White Lubber line

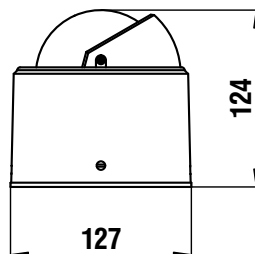

Rosa 5° / *Card graduations 5°*

Bianca/*White*

Grigia/*Grey*

Nera/*Black*

Colori bussola / *compass colors*

BZ3 installazione a chiesuola / *Binnacle mounted*

CARATTERISTICHE / *KEY FEATURES*

Sospensione: Cardanica interna	<i>Gimbal type: Internally gimbale</i>
Illuminazione: 12V di serie (24V a richiesta)	<i>Lighting: 12V standard (24V on request)</i>
Letture: Posteriore	<i>Reading: Rear</i>
Divisione rosa: 5°	<i>Card graduations: 5°</i>
Diametro apparente: 3" - 80 mm	<i>Apparent card dia: 3" - 80 mm</i>
Per imbarcazioni ad alta velocità / normali	<i>For high speed boats / standard</i>
Compensazione incorporata	<i>Built-in compensation setting</i>
100% Riparabile	<i>100% Repairable</i>
Garanzia 3 anni	<i>Warranty 3 years</i>
Fabbricata 100% in Italia	<i>Handcrafted 100% in Italy</i>
Certificazione MED su richiesta	<i>MED certification on request</i>

CODICI ORDINAZIONE / *ORDER CODES*

62.00147.01 Nera Rosa nera - Alta velocità / <i>Black Black card - high speed</i>
62.00148.01 Nera Rosa nera / <i>Black Black card</i>
62.00314.01 Grigia Rosa blu - Alta velocità / <i>Grey Blue card - high speed</i>
62.00315.01 Grigia Rosa blu / <i>Grey Blue card</i>
62.00314.02 Bianca Rosa nera - Alta velocità / <i>White Black card - high speed</i>
62.00315.02 Bianca Rosa nera / <i>White Black card</i>

Accessori
Accessories



Calotta di protezione in tela

*Protective cover
Canvas hood*

62.00064.01

COMPASSES - ZENITH 3"



Linea di fede rossa
Red Lubber line

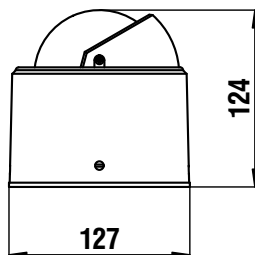

Rosa 5° / Card graduations 5°

Bianca/White

Grigia/Grey

Nera/Black

Colori bussola / compass colors

BZ3 installazione a chiesuola / Binnacle mounted

NEW

CARATTERISTICHE / KEY FEATURES

Sospensione: Cardanica interna	<i>Gimbal type: Internally gimbaled</i>
Illuminazione: 12V di serie (24V a richiesta)	<i>Lighting: 12V standard (24V on request)</i>
Letture: Frontale	<i>Reading: Direct</i>
Divisione rosa: 5°	<i>Card graduations: 5°</i>
Diametro apparente: 3" - 80 mm	<i>Apparent card dia: 3" - 80 mm</i>
Per imbarcazioni ad alta velocità / normali	<i>For high speed boats / standard</i>
Compensazione incorporata	<i>Built-in compensation setting</i>
100% Riparabile	<i>100% Repairable</i>
Garanzia 3 anni	<i>Warranty 3 years</i>
Fabbricata 100% in Italia	<i>Handcrafted 100% in Italy</i>
Certificazione MED su richiesta	<i>MED certification on request</i>

CODICI ORDINAZIONE / ORDER CODES

- 62.00448.01** Nera Rosa nera - Alta velocità / *Black Black card - high speed*
- 62.00449.01** Nera Rosa nera / *Black Black card*
- 62.00448.02** Bianca Rosa nera - Alta velocità / *White Black card - high speed*
- 62.00449.02** Bianca Rosa nera / *White Black card*
- 62.00448.03** Grigia Rosa blu - Alta velocità / *Grey Blue card - high speed*
- 62.00449.03** Grigia Rosa blu / *Grey blue card*

Accessori
Accessories



Calotta di protezione in tela

Protective cover
Canvas hood

62.00064.01



elenka 





Riviera

**BUSSOLE MAGNETICHE
MAGNETIC COMPASSES**



COMPASSES - ARTICA 2" 3/4



ARTICA 2" 3/4

Letture posteriore/Rear reading

Letture frontale/Direct reading

Bussola magnetica a incasso orizzontale

Horizontal flush mounted magnetic compass

BA1-2022

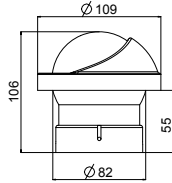

BA1-2022

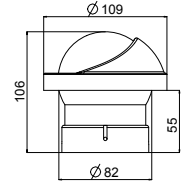

BA1

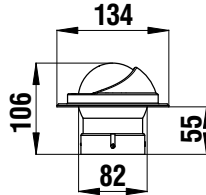

BA1

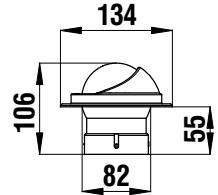

Bussola magnetica installazione con supporto a staffa

Bracket mounted magnetic compass

BA2

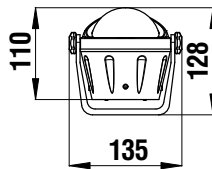

BA2

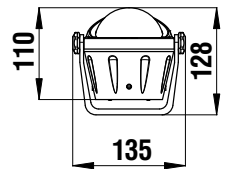

Bussola magnetica installazione a chiesuola

Binnacle mounted magnetic compass

BA3

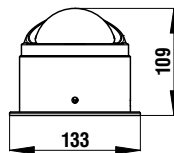

BA3

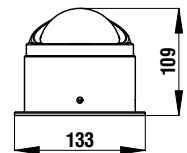

ARTICA 2" 3/4



CARATTERISTICHE GENERALI / STANDARD FEATURES

Diametro apparente 2"3/4 - 70 mm
Lettura: Posteriore - Frontale
Sospensione: Semi-Cardanica Interna
Rosa: Nera, blu 5°
Illuminazione 12V (24V su richiesta)
Per imbarcazioni normali
Compensazione incorporata
Schermo antiriflesso
100% Riparabile
Garanzia 3 anni
Fabbricata 100% in Italia
Certificazione MED su richiesta

Apparent card diameter 2"3/4 - 70 mm
Reading : Rear - Direct
Gymbal type: Internally half gimbaled
Card : Nera, blu /Black, blue 5°
Lighting 12V (24V su richiesta/on request)
For standard speed boats
Built-in compensation setting
anti-glare screen
100% Repairable
Warranty 3 years
Handcrafted 100% in Italy
MED certification on request

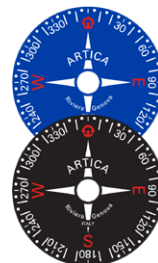

NON NECESSITA DI OMOLOGAZIONE PER NAVIGAZIONE ENTRO LE 6 MIGLIA
NO APPROVALS NEEDED FOR NAVIGATION WITHIN 6 MILES

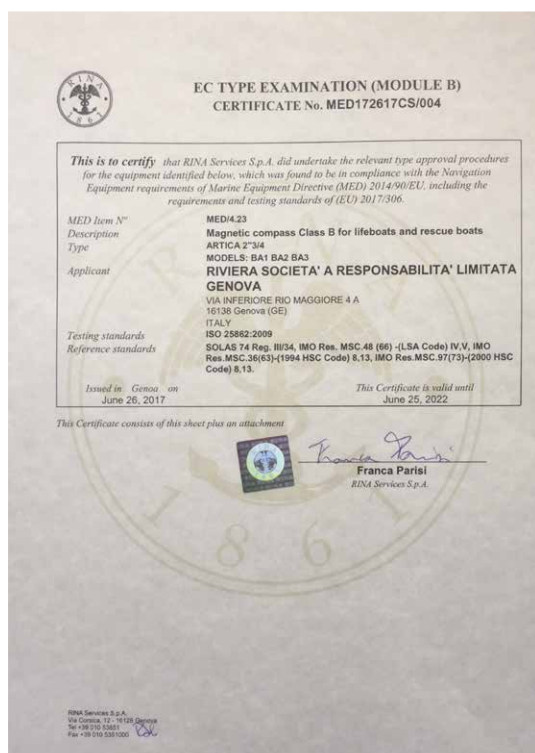

Su richiesta On request

 Certificato MED in accordo con la direttiva MED 2014/90/EU riguardo alle imbarcazioni di salvataggio e battelli di emergenza.

 MED Certification According to the directive MED 2014/90/EU, regarding lifeboats and rescue boats



Riviera

ARTICA 2" 3/4 BA1-2022

Su richiesta / On request



Certificato MED
MED certification



Linea di fede bianca
White Lubber line

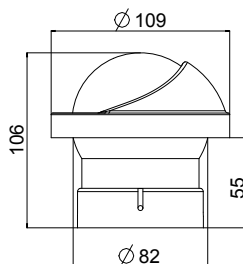

Rosa 5° / Card graduations 5°



Bianca/White

Grigia/Grey

Nera/Black

Colori bussola / compass colors

BA1 installazione ad incasso orizzontale / Horizontal flush mounted

NEW

CARATTERISTICHE / KEY FEATURES

Sospensione: semi-cardanica interna
 Illuminazione: 12V di serie (24V a richiesta)
 Lettura: Posteriore
 Divisione rosa: 5°
 Diametro apparente: 2" 3/4 - 70 mm
 Per imbarcazioni ad alta velocità / normali
 Compensazione incorporata
 100% Riparabile
 Garanzia 3 anni
 Fabbricata 100% in Italia
 Certificazione MED su richiesta

Gimbal type: Internally half gimbaled
Lighting: 12V standard (24V on request)
Reading: Rear
Card graduations: 5°
Apparent card dia: 2" 3/4 - 70 mm
For high speed boats / standard
Built-in compensation setting
100% Repairable
Warranty 3 anni/years
Handcrafted 100% in Italy
MED certification on request

CODICI ORDINAZIONE / ORDER CODES

62.00114.11 Nera Rosa nera / *Black Black card*
62.00301.11 Grigia Rosa blu / *Grey Blue card*
62.00301.12 Bianca Rosa nera / *White Black card*

COMPASSES - ARTICA 2" 3/4

Riviera **ARTICA 2" 3/4**
BA1-2022

Su richiesta / On request



Certificato MED
MED certification



Linea di fede rossa
Red Lubber line

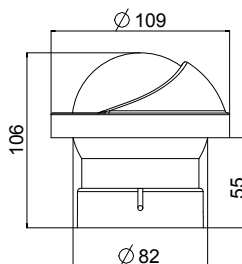

Rosa 5° / Card graduations 5°

Bianca/White

Nera/Black

BA1 installazione ad incasso orizzontale / Horizontal flush mounted

NEW

CARATTERISTICHE / KEY FEATURES

Sospensione: semi-cardanica interna	<i>Gimbal type: Internally half gimbale</i>
Illuminazione: 12V di serie (24V a richiesta)	<i>Lighting: 12V standard (24V on request)</i>
Letture: Frontale	<i>Reading: Direct</i>
Divisione rosa: 5°	<i>Card graduations: 5°</i>
Diametro apparente: 2" 3/4 - 70 mm	<i>Apparent card dia: 2" 3/4 - 70 mm</i>
Per imbarcazioni ad alta velocità / normali	<i>For high speed boats / standard</i>
Compensazione incorporata	<i>Built-in compensation setting</i>
100% Riparabile	<i>100% Repairable</i>
Garanzia 3 anni	<i>Warranty 3 anni/years</i>
Fabbricata 100% in Italia	<i>Handcrafted 100% in Italy</i>
Certificazione MED su richiesta	<i>MED certification on request</i>

CODICI ORDINAZIONE / ORDER CODES

62.00778.10 Nera Rosa nera / *Black Black card*
62.00778.11 Bianca Rosa nera / *White Black card*



Riviera

ARTICA 2" 3/4 BA1

Su richiesta / On request



Certificato MED
MED certification



Linea di fede bianca
White Lubber line

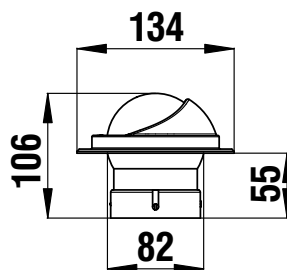

Rosa 5° / Card graduations 5°



Bianca/White

Grigia/Grey

Nera/Black

Colori bussola / compass colors

BA1 installazione ad incasso orizzontale / Horizontal flush mounted

CARATTERISTICHE / KEY FEATURES

Sospensione: semi-cardanica interna
 Illuminazione: 12V di serie (24V a richiesta)
 Lettura: Posteriore
 Divisione rosa: 5°
 Diametro apparente: 2" 3/4 - 70 mm
 Per imbarcazioni ad alta velocità / normali
 Compensazione incorporata
 100% Riparabile
 Garanzia 3 anni
 Fabbricata 100% in Italia
 Certificazione MED su richiesta

Gimbal type: Internally half gimbaled
Lighting: 12V standard (24V on request)
Reading: Rear
Card graduations: 5°
Apparent card dia: 2" 3/4 - 70 mm
For high speed boats / standard
Built-in compensation setting
100% Repairable
Warranty 3 anni/years
Handcrafted 100% in Italy
MED certification on request

CODICI ORDINAZIONE / ORDER CODES

62.00114.01 Nera Rosa nera / Black Black card
 62.00301.01 Grigia Rosa blu / Grey Blue card
 62.00301.02 Bianca Rosa nera / White Black card

ARTICA 2" 3/4
BA1

Riviera

Su richiesta / On request



Certificato MED
 MED certification



Linea di fede rossa
 Red Lubber line

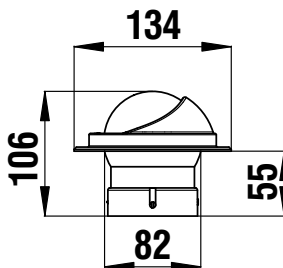

Rosa 5° / Card graduations 5°

Bianca/White

Nera/Black

Colori bussola / compass colors

BA1 installazione ad incasso orizzontale / Horizontal flush mounted

NEW

CARATTERISTICHE / KEY FEATURES

Sospensione: semi-cardanica interna	<i>Gimbal type: Internally half gimbale</i>
Illuminazione: 12V di serie (24V a richiesta)	<i>Lighting: 12V standard (24V on request)</i>
Letture: Frontale	<i>Reading: Direct</i>
Divisione rosa: 5°	<i>Card graduations: 5°</i>
Diametro apparente: 2" 3/4 - 70 mm	<i>Apparent card dia: 2" 3/4 - 70 mm</i>
Per imbarcazioni ad alta velocità / normali	<i>For high speed boats / standard</i>
Compensazione incorporata	<i>Built-in compensation setting</i>
100% Riparabile	<i>100% Repairable</i>
Garanzia 3 anni	<i>Warranty 3 anni/years</i>
Fabbricata 100% in Italia	<i>Handcrafted 100% in Italy</i>
Certificazione MED su richiesta	<i>MED certification on request</i>

CODICI ORDINAZIONE / ORDER CODES

62.00778.00 Nera Rosa nera / *Black Black card*
62.00778.01 Bianca Rosa nera / *White Black card*

155 COMPASSES - ARTICA 2" 3/4



Riviera

ARTICA 2" 3/4 BA2

Su richiesta / On request



Certificato MED
MED certification



Linea di fede bianca
White Lubber line

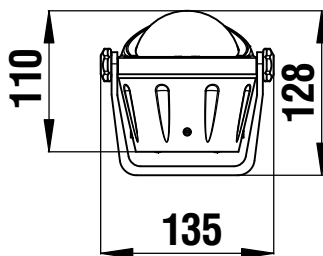

Rosa 5° / Card graduations 5°



Bianca/White

Grigia/Grey

Nera/Black

Colori bussola / compass colors

BA2 installazione a staffa / Bracket mounted

CARATTERISTICHE / KEY FEATURES

Sospensione: semi-cardanica interna
 Illuminazione: 12V di serie (24V a richiesta)
 Lettura: Posteriore
 Divisione rosa: 5°
 Diametro apparente: 2" 3/4 - 70 mm
 Per imbarcazioni ad alta velocità / normali
 Compensazione incorporata
 100% Riparabile
 Garanzia 3 anni
 Fabbricata 100% in Italia
 Certificazione MED su richiesta

Gimbal type: Internally half gimbaled
Lighting: 12V standard (24V on request)
Reading: Rear
Card graduations: 5°
Apparent card dia: 2" 3/4 - 70 mm
For high speed boats / standard
Built-in compensation setting
100% Repairable
Warranty 3 anni/years
Handcrafted 100% in Italy
MED certification on request

CODICI ORDINAZIONE / ORDER CODES

62.00115.01 Nera Rosa nera / Black Black card
 62.00304.01 Grigia Rosa blu / Grey Blue card
 62.00304.02 Bianca Rosa nera / White Black card

Riviera **ARTICA 2" 3/4**
BA2

Su richiesta / On request



Certificato MED
MED certification



Linea di fede rossa
Red Lubber line

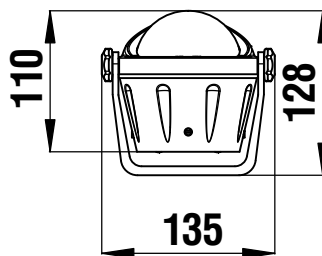

Rosa 5° / Card graduations 5°

Bianca/White

Nera/Black

Colori bussola / compass colors

BA2 installazione a staffa / Bracket mounted

NEW

CARATTERISTICHE / KEY FEATURES

Sospensione: semi-cardanica interna	<i>Gimbal type: Internally half gimbale</i>
Illuminazione: 12V di serie (24V a richiesta)	<i>Lighting: 12V standard (24V on request)</i>
Letture: Frontale	<i>Reading: Direct</i>
Divisione rosa: 5°	<i>Card graduations: 5°</i>
Diametro apparente: 2" 3/4 - 70 mm	<i>Apparent card dia: 2" 3/4 - 70 mm</i>
Per imbarcazioni ad alta velocità / normali	<i>For high speed boats / standard</i>
Compensazione incorporata	<i>Built-in compensation setting</i>
100% Riparabile	<i>100% Repairable</i>
Garanzia 3 anni	<i>Warranty 3 anni/years</i>
Fabbricata 100% in Italia	<i>Handcrafted 100% in Italy</i>
Certificazione MED su richiesta	<i>MED certification on request</i>

CODICI ORDINAZIONE / ORDER CODES

62.00779.00 Nera Rosa nera / *Black Black card*
62.00779.01 Bianca Rosa nera / *White Black card*



ARTICA 2" 3/4

Riviera BA3

Su richiesta / On request



Certificato MED
MED certification



Linea di fede bianca
White Lubber line

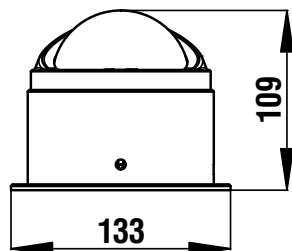

Rosa 5° / Card graduations 5°



Bianca/White

Grigia/Grey

Nera/Black

Colori bussola / compass colors

BA3 installazione a chiesuola / Binnacle mounted

CARATTERISTICHE / KEY FEATURES

Sospensione: semi-cardanica interna
Illuminazione: 12V di serie (24V a richiesta)
Lettura: Posteriore
Divisione rosa: 5°
Diametro apparente: 2" 3/4 - 70 mm
Per imbarcazioni ad alta velocità / normali
Compensazione incorporata
100% Riparabile
Garanzia 3 anni
Fabbricata 100% in Italia
Certificazione MED su richiesta

Gimbal type: Internally half gimballed
Lighting: 12V standard (24V on request)
Reading: Rear
Card graduations: 5°
Apparent card dia: 2" 3/4 - 70 mm
For high speed boats / standard
Built-in compensation setting
100% Repairable
Warranty 3 anni/years
Handcrafted 100% in Italy
MED certification on request

CODICI ORDINAZIONE / ORDER CODES

62.00116.01 Nera Rosa nera / *Black Black card*
62.00305.01 Grigia Rosa blu / *Grey Blue card*
62.00305.02 Bianca Rosa nera / *White Black card*

Riviera **ARTICA 2" 3/4**
BA3

Su richiesta / On request



Certificato MED
MED certification



Linea di fede rossa
Red Lubber line

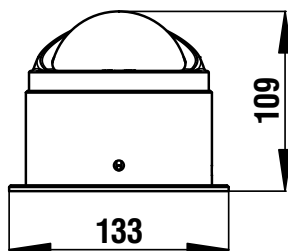

Rosa 5° / Card graduations 5°

Bianca/White

Nera/Black

Colori bussola / compass colors

BA3 installazione a chiesuola / Binnacle mounted

NEW

CARATTERISTICHE / KEY FEATURES

Sospensione: semi-cardanica interna	<i>Gimbal type: Internally half gimbale</i>
Illuminazione: 12V di serie (24V a richiesta)	<i>Lighting: 12V standard (24V on request)</i>
Letture: Frontale	<i>Reading: Direct</i>
Divisione rosa: 5°	<i>Card graduations: 5°</i>
Diametro apparente: 2" 3/4 - 70 mm	<i>Apparent card dia: 2" 3/4 - 70 mm</i>
Per imbarcazioni ad alta velocità / normali	<i>For high speed boats / standard</i>
Compensazione incorporata	<i>Built-in compensation setting</i>
100% Riparabile	<i>100% Repairable</i>
Garanzia 3 anni	<i>Warranty 3 anni/years</i>
Fabbricata 100% in Italia	<i>Handcrafted 100% in Italy</i>
Certificazione MED su richiesta	<i>MED certification on request</i>

CODICI ORDINAZIONE / ORDER CODES

62.00780.00 Nera Rosa nera / *Black Black card*
62.00780.01 Bianca Rosa nera / *White Black card*



Riviera

BUSSOLE MAGNETICHE
MAGNETIC COMPASSES

COMPASSES - STELLA 2" 1/2



Riviera **STELLA 2" 1/2**
BS2

NON NECESSITA DI OMOLOGAZIONE
PER NAVIGAZIONE ENTRO LE 6 MIGLIA
NO APPROVALS NEEDED
FOR NAVIGATION WITHIN 6 MILES

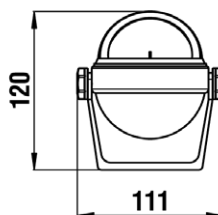

Rosa 5° / Card graduations 5°

Bianca/White

Grigia/Grey

Nera/Black

Colori bussola / compass colors

BS2 installazione a staffa / Bracket mounted

CARATTERISTICHE / KEY FEATURES

Sospensione: A spillo	<i>Gimbal type: Jewel and pivot movements</i>
Illuminazione: 12V di serie (24V a richiesta)	<i>Lighting: 12V standard (24V on request)</i>
Letture: Frontale	<i>Reading: Direct</i>
Divisione rosa: 5°	<i>Card graduations: 5°</i>
Diametro apparente: 3" - 80 mm	<i>Apparent card dia: 2" 1/2 - 65 mm</i>
Per imbarcazioni ad alta velocità / normali	<i>For high speed boats / standard</i>
Compensazione incorporata	<i>Built-in compensation setting</i>
Garanzia 3 anni	<i>Warranty 3 years</i>
Fabbricata 100% in Italia	<i>Handcrafted 100% in Italy</i>

CODICI ORDINAZIONE / ORDER CODES

- 62.00068.02** Nera Rosa nera / *Black Black card*
- 62.00367.02** Bianca Rosa nera / *White Black card*
- 62.00355.02** Grigia Rosa Blu / *Grey Blue card*



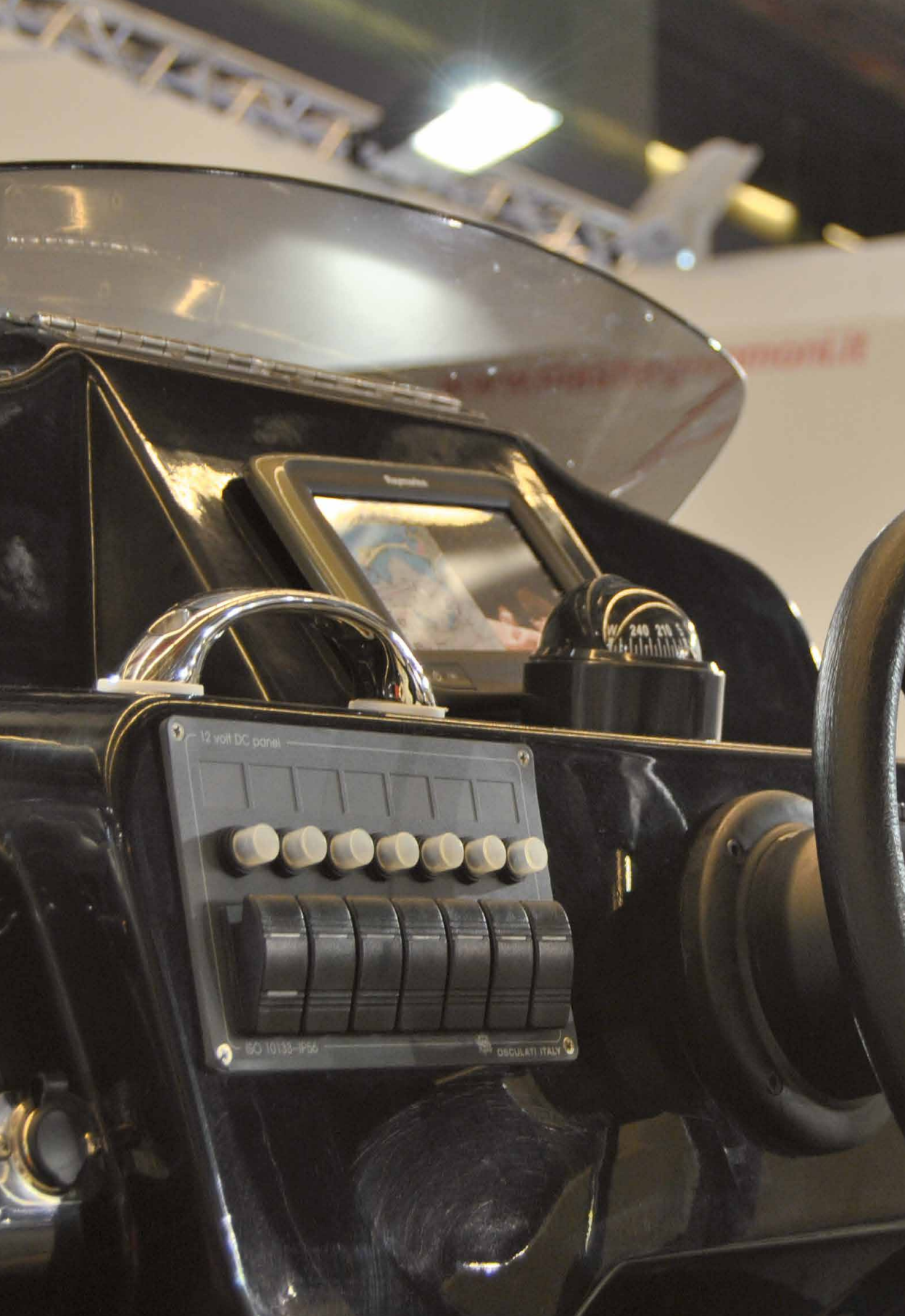

12 volt DC panel

ISO 10133-IP56

OSCOLATI ITALY

Riviera **STELLA 2" 1/2** **BS1**

NON NECESSITA DI OMOLOGAZIONE
PER NAVIGAZIONE ENTRO LE 6 MIGLIA
NO APPROVALS NEEDED
FOR NAVIGATION WITHIN 6 MILES

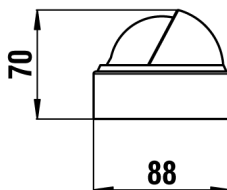

Rosa 5° / Card graduations 5°

Bianca/White

Grigia/Grey

Nera/Black

Colori bussola / compass colors

BS1 installazione a baionetta / Bayonet joint mounted

CARATTERISTICHE / KEY FEATURES

Sospensione: A spillo	<i>Gimbal type: Jewel and pivot movements</i>
Illuminazione: 12V di serie (24V a richiesta)	<i>Lighting: 12V standard (24V on request)</i>
Letture: Frontale	<i>Reading: Direct</i>
Divisione rosa: 5°	<i>Card graduations: 5°</i>
Diametro apparente: 3" - 80 mm	<i>Apparent card dia: 2" 1/2 - 65 mm</i>
Per imbarcazioni ad alta velocità / normali	<i>For high speed boats / standard</i>
Compensazione incorporata	<i>Built-in compensation setting</i>
Garanzia 3 anni	<i>Warranty 3 years</i>
Fabbricata 100% in Italia	<i>Handcrafted 100% in Italy</i>

CODICI ORDINAZIONE / ORDER CODES

- 62.00058.02** Nera Rosa nera / *Black Black card*
- 62.00059.02** Bianca Rosa nera / *White Black card*
- 62.00354.02** Grigia Rosa Blu / *Grey Blue card*

Accessori
Accessories



61.01054.00

Staffetta
Bracket



163 COMPASSES - STELLA 2" 1/2



Riviera

**BUSSOLE MAGNETICHE
MAGNETIC COMPASSES**



COMPASSES - ARIES 2" 1/2

ARIES 2" 1/2 BAR

Riviera

NON NECESSITA DI OMOLOGAZIONE
PER NAVIGAZIONE ENTRO LE 6 MIGLIA
NO APPROVALS NEEDED
FOR NAVIGATION WITHIN 6 MILES

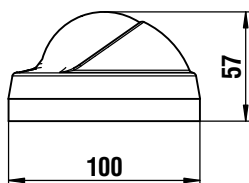

Total Bianca/Total White



Nera/Black



Gialla/Yellow



Rossa/Red



Blu/Blue



Total Nera/Total Black



Colori bussola / compass colors

BAR installazione a baionetta / Bayonet joint mounted

CARATTERISTICHE / KEY FEATURES

Sospensione: A spillo	<i>Gimbal type: Jewel and pivot movements</i>
Illuminazione: 12V di serie (24V a richiesta)	<i>Lighting: 12V standard (24V on request)</i>
Letture: Frontale	<i>Reading: Direct</i>
Divisione rosa: 5°	<i>Card graduations: 5°</i>
Diametro apparente: 3" - 80 mm	<i>Apparent card dia: 2" 1/2 - 65 mm</i>
Per imbarcazioni ad alta velocità / normali	<i>For high speed boats / standard</i>
Compensazione incorporata	<i>Built-in compensation setting</i>
Garanzia 3 anni	<i>Warranty 3 years</i>
Fabbricata 100% in Italia	<i>Handcrafted 100% in Italy</i>

CODICI ORDINAZIONE / ORDER CODES

- 62.00405.04 Base **Nera** Rosa nera / *Black base Black card*
- 62.00405.05 Base **Gialla** Rosa nera / *Yellow base Black card*
- 62.00405.06 Base **Rossa** Rosa nera / *Red base Black card*
- 62.00405.07 Base **Blu** Rosa nera / *Blue base Black card*
- 62.00405.08 **Bianca** Rosa nera / *Total White Black card*
- 62.00405.09 **Nera** Rosa nera / *Total Black Black card*

Accessori
Accessories



Staffetta
Bracket

61.01054.00

- 62.00405.14 Base **Nera** Rosa nera - Con luce / *Black base Black card - With light*
- 62.00405.15 Base **Gialla** Rosa nera - Con luce / *Yellow base Black card - With light*
- 62.00405.16 Base **Rossa** Rosa nera - Con luce / *Red base Black card - With light*
- 62.00405.17 Base **Blu** Rosa nera - Con luce / *Blue base Black card - With light*
- 62.00405.18 **Bianca** Rosa nera - Con luce / *Total White Black card - With light*
- 62.00405.19 **Nera** Rosa nera - Con luce / *Total Black Black card - With light*

COMPASSES - ARIES 2" 1/2



Riviera

BUSSOLE MAGNETICHE
MAGNETIC COMPASSES



COMPASSES - COMET 2"

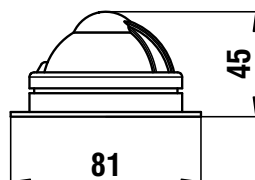

Rosa 5° / Card graduations 5°

Grigia/Grey

Nera/Black

Colori bussola / compass colors

BC1 installazione a chiesuola / Binnacle mounted

CARATTERISTICHE / KEY FEATURES

Sospensione: A spillo	<i>Gimbal type: Jewel and pivot movements</i>
Illuminazione: 12V di serie (24V a richiesta)	<i>Lighting: 12V standard (24V on request)</i>
Letture: Frontale	<i>Reading: Direct</i>
Divisione rosa: 5°	<i>Card graduations: 5°</i>
Diametro apparente: 3" - 80 mm	<i>Apparent card dia: 2" 48 mm</i>
Per imbarcazioni ad alta velocità / normali	<i>For high speed boats / standard</i>
Compensazione incorporata	<i>Built-in compensation setting</i>
Garanzia 3 anni	<i>Warranty 3 years</i>
Fabbricata 100% in Italia	<i>Handcrafted 100% in Italy</i>

CODICI ORDINAZIONE / ORDER CODES

- 62.00202.01** Nera Rosa nera / *Black Black card*
62.00316.01 Grigia Rosa Nera / *Grey Black card*





COMET 2"

Riviera **BC2**

NON NECESSITA DI OMOLOGAZIONE
PER NAVIGAZIONE ENTRO LE 6 MIGLIA
NO APPROVALS NEEDED
FOR NAVIGATION WITHIN 6 MILES

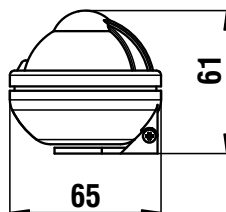

Rosa 5° / Card graduations 5°

Grigia/Grey

Nera/Black

Colori bussola / compass colors

BC2 installazione con supporto a staffa / Bracket mounted

CARATTERISTICHE / KEY FEATURES

Sospensione: A spillo	<i>Gimbal type: Jewel and pivot movements</i>
Illuminazione: 12V di serie (24V a richiesta)	<i>Lighting: 12V standard (24V on request)</i>
Letture: Frontale	<i>Reading: Direct</i>
Divisione rosa: 5°	<i>Card graduations: 5°</i>
Diametro apparente: 3" - 80 mm	<i>Apparent card dia: 2" 48 mm</i>
Per imbarcazioni ad alta velocità / normali	<i>For high speed boats / standard</i>
Compensazione incorporata	<i>Built-in compensation setting</i>
Garanzia 3 anni	<i>Warranty 3 years</i>
Fabbricata 100% in Italia	<i>Handcrafted 100% in Italy</i>

CODICI ORDINAZIONE / ORDER CODES

- 62.00203.01** Nera Rosa nera / *Black Black card*
62.00317.01 Grigia Rosa Nera / *Grey Black card*



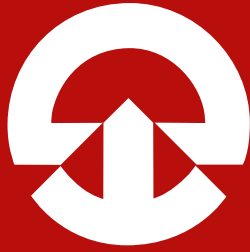

Riviera

BUSSOLE MAGNETICHE DA RILEVAMENTO
MAGNETIC COMPASSES HANDBEARING



COMPASSES - PRISMA 2" 1/4



PRISMA 2" 1/4

Riviera **BPS**



Rosa 1° / *Card graduations 1°*

Nera/Black

Colori bussola / *compass colors*

BC2 installazione con supporto a staffa / Bracket mounted

CARATTERISTICHE / KEY FEATURES

Sospensione: A spillo	<i>Gimbal type: Jewel and pivot movements</i>
Illuminazione: Di serie 1,5 V CC a batteria	<i>Lighting: Standard 1,5V DC (battery)</i>
Letture: Mediante prisma	<i>Reading: Prismatic lens</i>
Divisione rosa: 1°	<i>Card graduations: 1°</i>
Diametro apparente: 2" - 1/4 (57,5mm)	<i>Apparent card dia: 2" 1/4 (57,5mm)</i>
Per imbarcazioni ad alta velocità / normali	<i>For high speed boats / standard</i>
Dispositivo a trappola d'aria	<i>Air bubble trap</i>
100% Riparabile	<i>100% Repairable</i>
Garanzia 3 anni	<i>Warranty 3 years</i>
Fabbricata 100% in Italia	<i>Handcrafted 100% in Italy</i>

CODICI ORDINAZIONE / ORDER CODES

62.00093.01

COMPASSES - PRISMA 2" 1/4

Accessori
Accessories



62.00106.01

Custodia
in legno di faggio

Wooden box



62.00105.01

Custodia in stoffa
imbottita

Carry-on case



Riviera

**BUSSOLE MAGNETICHE DA RILEVAMENTO
MAGNETIC COMPASSES HANDBEARING**



COMPASSES - ORION/MIZAR 1" 7/8



ORION/MIZAR 1" 7/8

CARATTERISTICHE GENERALI / STANDARD FEATURES

- **Diametro apparente 1" 7/8**
Apparent diameter 1" 7/8
- **Lettura frontale**
Direct reading
- **Gradazione di 10°**
10° graduation
- **Sospensione a spillo**
Jewel and pivot movements
- **Galleggiante**
Floating
- **Resistente agli urti**
Shock resistant

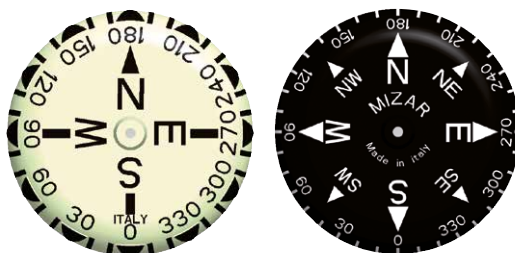

BO da rilevamento serie Orion / Handbearing Orion series

CARATTERISTICHE / KEY FEATURES

Sospensione / <i>Gimbal type:</i>	A spillo / <i>Jewel and pivot movements</i>
Lettura / <i>Reading:</i>	Frontale / <i>Direct</i>
Divisione rosa / <i>Card graduations:</i>	10° / 10°
Dia. apparente / <i>Apparent card dia:</i>	1" 7/8 / 1" 7/8

CODICI ORDINAZIONE / ORDER CODES

- 62.00484.00** Grigia Rosa luminescente / *Grey Luminescent card*
- 62.00484.01** Gialla Rosa luminescente / *Yellow Luminescent card*
- 62.00484.02** Rossa Rosa luminescente / *Red Luminescent card*
- 62.00484.03** Blu Rosa luminescente / *Blue Luminescent card*
- 62.00484.04** Nera Rosa luminescente / *Black Luminescent card*

Rosa 10°
Card graduations 10°



BM da rilevamento serie Mizar / Handbearing Mizar series

CARATTERISTICHE / KEY FEATURES

Sospensione / <i>Gimbal type:</i>	A spillo / <i>Jewel and pivot movements</i>
Lettura / <i>Reading:</i>	Frontale / <i>Direct</i>
Divisione rosa / <i>Card graduations:</i>	10° / 10°
Dia. apparente / <i>Apparent card dia:</i>	1" 7/8 / 1" 7/8

CODICI ORDINAZIONE / ORDER CODES

- 62.00420.00** Grigia Rosa Black / *Grigia Black card*
- 62.00420.01** Gialla Rosa Black / *Yellow Black card*
- 62.00420.02** Rossa Rosa Black / *Red Black card*
- 62.00420.03** Blu Rosa Black / *Blue Black card*
- 62.00420.04** Nera Rosa Black / *Black Black card*

Rosa 10°
Card graduations 10°

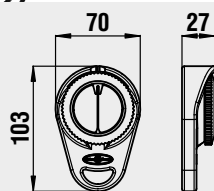

Quadrante luminescente.
Ghiera rotante. Galleggiante.
Resistente agli urti.

*Luminescent Card, Rotating Ring,
Floating, Shock Resistant.*

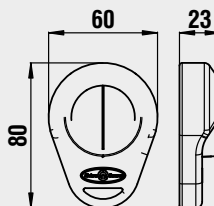

Quadrante nero. Galleggiante.
Resistente agli urti.

*Black Card, Floating,
Shock Resistant.*



Riviera

**BUSSOLE SUBACQUEE
DIVING COMPASSES**



COMPASSES - DIVING COMPASSES



DIVING "STANDARD"

CARATTERISTICHE GENERALI / STANDARD FEATURES

- **Liquido all'interno**
Oil filled
- **Lettura dall'alto o laterale attraverso un'apposita finestra di lettura**
Read from above or from the side through a special reading window
- **2 magneti per una risposta molto veloce**
Very fast response - 2 magnets
- **Rosa luminescente con gradazione 10°**
Luminescent card with 10° gradation
- **Ghiera girevole a scatti graduata**
Swivel trigger graduated ring
- **Diametro: 60 mm. / 2.3"**
Diameter: 60 mm / 2.3"
- **Altezza: 25 mm.**
Height: 25 mm.
- **Peso: 40 gr.**
Weight: 40 gr.
- **Opzioni: Emisfero Nord; Emisfero Sud**
Options: Northern hemisphere; Southern hemisphere



Bussola standard – Solo Capsula
Standard Compass - Capsule only



Bussola standard – versione da polso
Standard Compass - wrist model



Bussola standard - Versione con corda elastica
Standard compass - bungee cord model



Bussola standard + fondina
Standard compass + holster

STANDARD Solo capsula / Capsule only



Lettura laterale
Side reading



CODICI ORDINAZIONE / *ORDER CODES*

62.00900.00

STANDARD Versione da polso / Wrist model



Lettura laterale
Side reading



CODICI ORDINAZIONE / *ORDER CODES*

62.00900.01

STANDARD Versione con corda elastica / Bungee cord model



Lettura laterale
Side reading



CODICI ORDINAZIONE / *ORDER CODES*

62.00900.02

STANDARD + fondina / + holster



CODICI ORDINAZIONE / *ORDER CODES*

62.00900.03

Solo capsula

Opzioni: Emisfero Nord;
Emisfero Sud;

Capsule only

Options: Northern hemisphere;
Southern hemisphere;

Un ampio cinturino, conformato anatomicamente nella sua parte inferiore, permette di fissare stabilmente la bussola "Standard" al polso.

Peso: 90 gr.

Opzioni: Emisfero Nord;
Emisfero Sud;

A wide band, which fits anatomically into its lower part, means the "Standard" compass can be attached stably to the wrist.

Weight: 90 gr.

Options: Northern hemisphere;
Southern hemisphere;

Bussola "Standard" montata su supporto con corda elastica.

Peso: 65 gr.

Opzioni: Emisfero Nord;
Emisfero Sud;

"Standard" Compass bungee cord mounted is far easier to do than buckled straps and is depth-compensating.

Weight: 65 gr.

Options: Northern hemisphere;
Southern hemisphere;

Bussola "Standard" versione per installazione sul tubo.

Opzioni: Emisfero Nord;
Emisfero Sud;

"Standard Compass" for mounting up to the hose.

Options: Northern hemisphere;
Southern hemisphere;





DIVING "PRO"

CARATTERISTICHE GENERALI / STANDARD FEATURES

- **Angolo di inclinazione della rosa fino a 30° garantendo sempre una rapida risposta**
Tilt allows the compass to be held at an angle of up to 30° and still respond quickly and accurately
- **2 magneti per una rapida risposta**
Very fast response - 2 magnets
- **Lettura laterale e superiore**
Top or side reading
- **Numeri ben leggibili e chiari**
Bold numbers for easy reading
- **Rosa luminescente**
Luminescent floating card
- **Diametro: 56 mm. / 2.2"**
Diameter: 56 mm / 2.2"
- **Altezza: 33 mm.**
Height: 33 mm.
- **Peso: 55 gr.**
Weight: 55 gr.
- **Opzioni: Emisfero Nord; Emisfero Sud**
Options: Northern hemisphere; Southern hemisphere



Bussola Pro – Solo Capsula
Pro Compass - Capsule only



Bussola Pro – versione da polso
Pro Compass - wrist model



Bussola Pro - Versione con corda elastica nera
Pro compass - bungee cord model black



Bussola Pro - Versione con corda elastica grigia
Pro compass - bungee cord model grey

PRO Solo capsula / Capsule only



Letture laterale
Side reading



CODICI ORDINAZIONE / **ORDER CODES**

62.00901.00

PRO Versione da polso / wrist model



Letture laterale
Side reading



CODICI ORDINAZIONE / **ORDER CODES**

62.00901.01

PRO Versione con corda elastica / Bungee cord model



Letture laterale / *Side reading*



CODICI ORDINAZIONE / **ORDER CODES**

62.00901.02 Nera / *Black*

62.00901.03 Grigia / *Grey*

Solo capsula

Opzioni: Emisfero Nord;
Emisfero Sud;

Capsule only

Opzioni: Northern hemisphere;
Southern hemisphere;

Un ampio cinturino, conformato anatomicamente nella sua parte inferiore, permette di fissare stabilmente la bussola "Pro" al polso.

Peso: 110 gr.

Opzioni: Emisfero Nord;
Emisfero Sud;

A wide band, which fits anatomically into its lower part, means the "Pro" compass can be attached stably to the wrist.

Weight: 110 gr.

Opzioni: Northern hemisphere;
Southern hemisphere;

Bussola "Pro" montata su supporto con corda elastica.

Peso: 80 gr.

Opzioni: Emisfero Nord;
Emisfero Sud;

"Pro" Compass bungee cord mounted is far easier to do than buckled straps and is depth-compensating.

Weight: 80 gr .

Opzioni: Northern hemisphere;
Southern hemisphere;





BUSSOLE SUBACQUEE / DIVING COMPASSES

SERIE DIVING "2K" / "2K" DIVING SERIES

CARATTERISTICHE GENERALI / STANDARD FEATURES

- **Liquido all'interno**
Oil filled
- **Lettura dall'alto o laterale attraverso un'apposita finestra di lettura**
Read from above or from the side through a special reading window
- **2 magneti per una risposta molto veloce**
Very fast response - 2 magnets
- **Rosa luminescente con gradazione 10°**
Luminescent card with 10° gradation
- **Ghiera girevole a scatti graduata**
Swivel trigger graduated ring
- **Diametro: 48 mm. / 1.8"**
Diameter: 48 mm. / 1.8"
- **Altezza: 13 mm.**
Height: 13 mm.
- **Peso: 33 gr.**
Weight: 33 gr.
- **Opzioni: Emisfero Nord; Emisfero Sud**
Options: Northern hemisphere; Southern hemisphere



Bussola 2K – Solo Capsula
Standard Compass - Capsule only



Bussola 2K – versione da polso
Standard Compass - wrist model

2K Solo capsula / Capsule only



CODICI ORDINAZIONE / **ORDER CODES**
62.00902.00



Lettura laterale
Side reading

Solo capsula
Opzioni: Emisfero Nord;
Emisfero Sud;

Capsule only
Options: Northern hemisphere;
Southern hemisphere;

2K Versione da polso / wrist model



CODICI ORDINAZIONE / **ORDER CODES**
62.00902.01

Lettura laterale
Side reading



Un ampio cinturino, conformato anatomicamente nella sua parte inferiore, permette di fissare stabilmente la bussola "2k" al polso
Peso: 85 gr.
Opzioni: Emisfero Nord;
Emisfero Sud;

A wide band, which fits anatomically into its lower part, means the "2k" compass can be attached stably to the wrist
Weight: 85 gr
Options: Northern hemisphere;
Southern hemisphere



ORDINI / ORDERS

Al fine di evitare disagi nell'esecuzione degli ordini si prega di indicare sempre:

1. CODICE ARTICOLO - 2. DESCRIZIONE ARTICOLO

In caso contrario non assumiamo alcuna responsabilità per eventuali errori d'interpretazione derivanti da indicazioni insufficienti.

Gli ordini pervenuti a mezzo agenti e rappresentanti, o trasmessoci direttamente, verranno immediatamente confermati, tale conferma vale come accettazione se nulla riceveremo entro il termine di 5 giorni.

Per ordini che non raggiungono l'importo minimo di Euro 150,00 al netto verranno addebitate Euro 13,00 per spese di fatturazione.

Le quantità di ordini a saldo, verranno spedite appena possibile, ed unitamente ad un nuovo ordine per importi non inferiori a Euro 150,00.

In order to avoid misunderstanding, please write your orders specifying:

1. THE ARTICLE P/N - 2. THE ARTICLE DESCRIPTION

Otherwise, we do not take any responsibility for possible interpretation mistakes which are derived from insufficient information.

The orders sent by agents or directly, will be confirmed to the customer and considered accepted in case we should not receive reply within 5 days.

We cannot accept orders for less than Euro 150,00 net. For orders with a lower amount we have to apply a special invoice charge of Euro 13,00.

Possible balance quantities will be sent as soon as possible or together with a new order, provided that the total amount is at least Euro 150,00.

SPEDIZIONI / DELIVERY

Le merci sono sempre vendute franco nostro magazzino di Genova. La merce viaggia sempre a rischio e pericolo del committente anche se spedita in porto franco. Le perdite totali o parziali delle merci durante il viaggio, avarie subite, contestazioni e ritardi della resa, non daranno diritto al committente di ritardare il pagamento stabilito o di respingere le eventuali ricevute bancarie presentate per l'incasso.

Le spedizioni verranno inoltre effettuate nei quantitativi minimi di confezione.

The goods are always sold ex-works Genoa. Goods are despatched at buyer's risk even if sent on DDP basis (transport costs prepaid).

Total or partial loss of the goods during the shipment, possible damage, contestation and delay in delivery, will not give any right to the buyer to delay the agreed payment or to reject relevant drafts. The delivery will be effected in least possible quantity packages.

PREZZI / PRICES

Secondo il listino in vigore al momento dell'ordine.

Non sono impegnativi e possono subire variazioni fino al momento della spedizione. Si intendono IVA esclusa.

Depending on the price list valid when placing the order.

The prices are no binding and are subject to possible change until the delivery. Prices do not include VAT.

MERCE RESA / RETURNS

Non si accettano reclami trascorsi otto giorni dal ricevimento della merce.

Non si accettano resi se non preventivamente autorizzati a mezzo scritto; qualora si riceva un reso non autorizzato siamo liberi di respingerlo.

Non si accettano resi se non in porto franco, qualora venga autorizzato un reso in porto assegnato si deve utilizzare il corriere da noi indicato.

Sulla bolla di reso è necessario indicare il numero e la data della fattura di acquisto.

La merce resa da noi autorizzata non verrà rimborsata, ma sostituita con altra di uguale valore. Tutte le spese di immagazzinaggio saranno addebitate.

We do not accept complaints after 8 days from goods receipt.

We do not accept returns if not previously authorized in written, so should we receive an unauthorized return, we are free to reject it.

We do not accept return unless on DDP basis, and in case we authorize a return with delivery at our charge, you have to send it via the shipping agent we suggest.

On relevant delivery note it is necessary to show the number and the date of purchase invoice.

The return goods which we authorize will be not refunded, but they will be replaced with another good of same value.

All stock expenses will be at your charge.

PAGAMENTI E SCONTI / PAYMENT AND DISCOUNT

Ordini inferiori a Euro 100,00 e prima fornitura in contrassegno. Le condizioni di pagamento vanno concordate con l'agente di zona o con la direzione della ditta Riviera che si riserva di variare le suddette condizioni e gli sconti pattuiti qualora si verificassero eventi che non permettano di continuare la politica concordata con il cliente.

Per ogni R.B. saranno addebitate Euro 3,62 per spese d'incasso. La R.B. respinta annulla eventuali ordini in corso.

Trascorso il termine stabilito per il pagamento decorreranno gli interessi commerciali.

Orders for less than Euro 100,00 and first orders on cash on delivery terms. The payment condition will have to be agreed upon with the area agent or with the Riviera sales management. They have the right to change a.m. conditions and discounts, if the politics agreed upon with the customer cannot be carried on, due to particular reasons. For any draft we will charge you Euro 3,62 for collection expenses.

An unaccepted draft cancels possible running orders.

On expiry of payment terms, trade interests will have to be applied.

GARANZIA / GUARANTEE

La Riviera s.r.l. Genova garantisce che i propri prodotti sono costruiti a regola d'arte e che sono privi di difetti di fabbricazione e di materiali.

Non sono comprese nella garanzia:

Avarie e rotture causate dal trasporto. Avarie e rotture causate da errata installazione o uso improprio. La garanzia non comprende in ogni caso l'integrale sostituzione del prodotto. La garanzia non comprende la manodopera necessaria alla sostituzione dei materiali, trasferte o trasporti.

Riviera s.r.l. Genova guarantees its products to be free from defects of workmanship or materials.

This guarantee does not cover:

Damages and breakage during the transport. Damages and breakage due to faulty installation or improper use. Guarantee does not include neither the complete replacement of the goods, nor the necessary labour for goods replacement, transfer or transport.

IMPORTANTE / IMPORTANT

Le caratteristiche tecniche ed estetiche degli articoli in visione sul nostro catalogo, sono indicative e possono variare in qualsiasi momento.

La Riviera s.r.l. Genova, declina ogni responsabilità per possibili inesattezze contenute nel presente catalogo, dovute ad eventuali errori di stampa o trascrizioni; si riserva il diritto di apporre ai propri articoli quelle modifiche che riterrà necessarie od utili senza pregiudicare le caratteristiche essenziali.

The technical and apparent characteristics of the products shown on our catalogue are approximate and may change at any moment.

Riviera s.r.l. Genova decline all responsibility for possible inaccuracy in this text, due to possible misprints or clerical errors and reserve the right to introduce any changes in the text if considered useful or necessary, without compromising the main feature of the articles

FORO COMPETENTE / CONTESTATION

Per ogni controversia sarà competente il Foro di Genova – Italia.

I diritti di pubblicazione del presente catalogo sono riservati alla ditta Riviera s.r.l. Genova. Tutte le riproduzioni anche parziali sono vietate.

For any contestation place of jurisdiction is Genoa - Italy. Riviera s.r.l. Genova have the copyright of this catalogue. No reproduction, even if partial, is allowed.

